

# OS2

Italian elegance  
for doors and  
windows



**ADI COMPASSO D'ORO**  
Winner 25 th Award



This catalogue wants to tell the OS2 window system. Winner of the "Compasso d'Oro", OS2 is a Secco Sistemi product born from the experience gained by the company in the area of windows' realization with reduced visual impact made of precious metals for architecture.

A complex of possibilities that OS2 can offer to architectural design, synthesis of years of competence in restoration ad contemporary world.

6	values
8	design
16	materials
40	technology
44	variants
46	types of opening
50	<i>windows</i>
66	<i>doors</i>
80	<i>lift and slide doors</i>
90	<i>pivot</i>
100	<i>folding</i>
110	<i>anti-burglary</i>
122	accessories
124	<i>handles</i>
126	<i>glazing beads</i>
128	<i>hinges</i>

# OS2 *values*

OS2 takes the name of the classification for the restoration of works of art, to remember its vocation for the past architecture, outcome of the long profitable relationship with designers. With its essential lines, the innovative types of opening and its original accessories, OS2 blends with the contemporary architecture as well.

The window of OS2 stands out for the elegance and the artisanal attention to details but especially for the happy solution of the relationship between the transparency of the glass and the solid lightness of the frame made of quality material like brass, Corten, stainless steel and galvanized steel.



# OS2 *design*

The foundation of the system is its accurate draw, awarded with "Compasso d'Oro", the design's Oscar, with the following motivation of the jury. «The relationship between the opening and the transparent surface have always been one of the challenges of the fenestration industry. OS2 lays down a new standard by combining thermal cut and insulation, with extremely small dimensions and a interesting aesthetic flexibility thanks to the profiles in Corten, steel and burnished brass».

OS2 provides 70 different profiles to realize the preferred design of the frame, allowing to release designer's creativity and to "returning to draw the frame".

1. handles in the same material as the profile
2. glazing beads of various shapes
3. central section for the two sashes of only 62mm
4. reduced hinges, same material as the profiles
5. lateral section only 47 mm
6. constant profiles on the whole perimeter

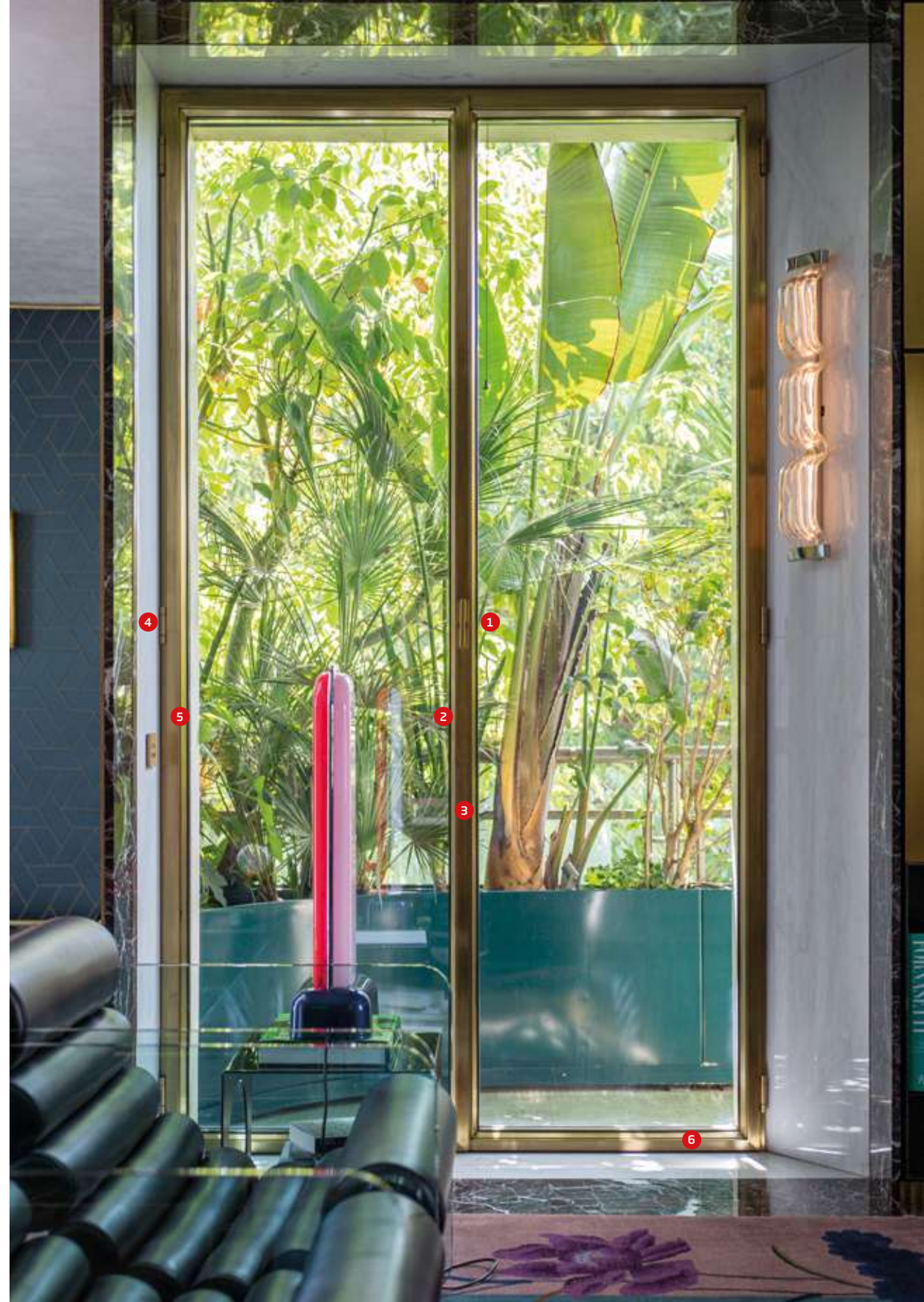

## profile design *examples*



The central section of the two-leaved door has a reduced section while the profiles framing it is pronounced.



The fixed glazing is divided into two parts by a horizontal profile of the same design as the perimetral border.



The glazing is measured by slender profiles with the two-leaved opening evident in the centre.



The glazing is characterised by the seamless pattern and undifferentiated profiles, making the two-leaved doors much less conspicuous.

## profile design *examples*



Double-sash windows with the same design for profiles which trace the external perimeter and the central section.



In the glazing panel the profiles of fixed and openable sashes have the same design.



In the double-sash windows the thin profiles tracing the perimeter of the casement have the same design as the central section in the front view.



Perimetral profiles in the front view have the same dimensions and design as those which divide the glazing into 4 parts.



**casa di Confine**  
designer: Subissati

# OS2 *materials*

The OS2 profiles are made in solid and tenacious materials with certified quality of oxidation and corrosion resistance. Materials for Secco are a source of design too, with their natural surfaces they affect the appearance of the frame and they can catch light or reflect it, they can have warm colors or austere ones and at the same time they have non-homogeneous surfaces for a continuous variant that emphasises the craftsmanship aspect of the product. All the used metals are 100% recyclable and they have high durability to concretize the sustainability of the product.







**scotch brite**

*316L stainless steel*

iron-chrome alloy nickel  
and molybdenum,  
cold rolled with  
scotch brite finish

**satin-finished brass**

*CuZn33 CW506L*

OT67 copper and zinc alloy,  
cold rolled and  
roughened, with  
satin finish



**blackened**

*316L stainless steel*

iron-chrome alloy nickel  
and molybdenum, cold  
rolled with hand  
burnished finish

**patinated brass**

*CuZn33 CW506L*

OT67 copper and zinc alloy,  
cold rolled and  
roughened,  
hand-burnished



## OS2 materials

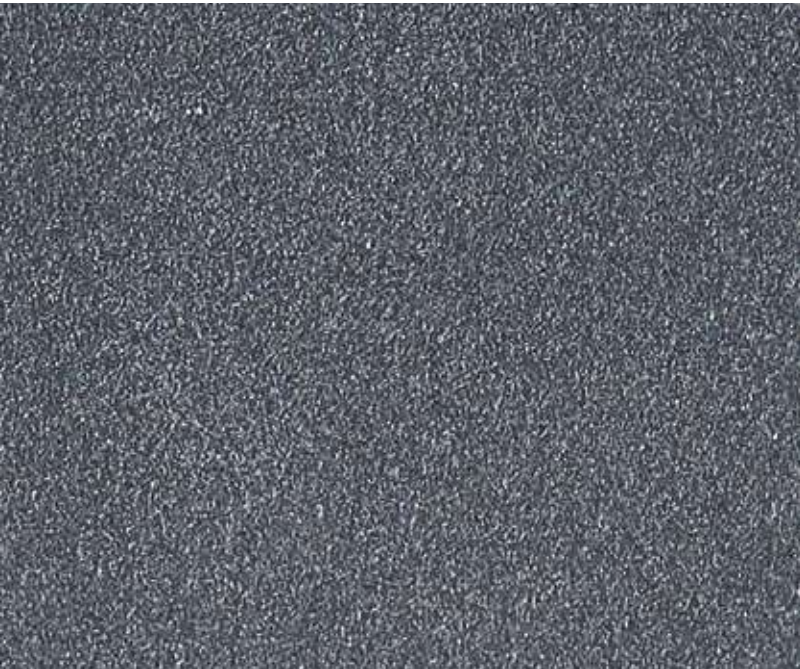

### **galvanised steel**

*FeP02 GZ 200*

Hot galvanized Iron alloy of carbon with Sendzimir system, skinpast finish. Requires liquid or powder coating



### **Corten steel**

*Fe 510 X*

Carbon iron alloy with high corrosion resistance (Cor) and tensile yield strength (ten), with oxidized finish





satin-finished  
brass

CALLE DEL FONTEGO  
DEI TEDESCHI



blackened  
stainless steel



blackened stainless steel



patinated brass



satin-finished  
brass

patinated brass



painting  
galvanised steel



corten steel

# OS2 *technology*

The result of years of experience, the OS2 technology supports the design and at the same time it allows to have high performance even with minimal profiles and fixtures with large dimensions, large estate and a great insulator.

The thermal break profiles of OS2 are made of two metal shells (cold profiled) joined together by extruded polyamide (9) made integral to the parts by polyurethane resin (8). Water, air and wind seals are guaranteed by open joint gaskets (5, 6, 7). The handling and closing hardware, made specifically for OS2, is placed in a window chamber (4) - the glazing beads (1) are fixed to the frame with concealed hook.

1. glazing bead
2. glazing slot  
up to 58 mm
3. internal and external overlap
4. hardware groove
5. Internal  
rebate gasket
6. external  
rebate gasket
7. central  
flipper gasket
8. structural thermal  
break - polyurethane
9. structural thermal  
break - polyamide





**Harella House - London**  
designer: Piercy & Company



# OS2 variants

The OS2 variants were designed to answer all the different needs of heat insulation and to allow the realization of new types of opening for this range of minimal profiles.

The numbers of OS2 correspond to the thickness not in profile view. Higher is the number, wider is the possibility of the window to have a thicker glass, from which derives more insulation.

## OS2 85

System for the realization of windows (also flap door) and doors with glass between 58 mm and 46 mm thick.



## OS2 75

System for the realization of windows (also flap door), doors, lift-slide, swing, book with glasses between 50 mm and 38 mm thick.



## OS2 65

System for the realization of windows, doors, balance, with glasses between 39 mm and 26 mm thick.



## OS2 40

System for the realization of doors and fixed with glasses between 21 mm and 6.5 mm thick.



# OS2 *types of opening*

The types of opening created by Secco Sistemi are not dictated only by tradition, but also to participate to the harmony of the facade of the building, to make an environment more accessible and to solve projects in restoration or in contemporary architecture.

OS2 offers the usual type of opening with profiles and new technologies with the goal of "returning to draw the frame".

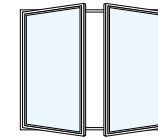

windows **p. 50**

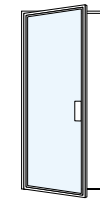

doors **p. 66**

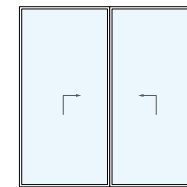

lift and slide doors **p.80**

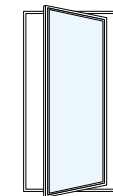

pivot **p. 90**

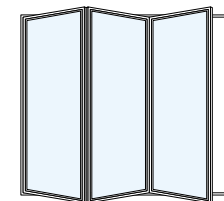

folding **p. 100**

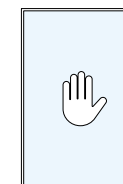

anti-burglary **p. 110**



**M3 - Mestre**  
designer: ANK architects

# windows OS2

The window or properly “window frames”, is the essential element of a building and with OS2 it can become, with elegance, the main character.

The OS2 window has new features for this typology of profiles: the central node is only 62 mm wide, lateral node 47 mm, the OS2 can have internal and external opening and the tilt and turn opening.



VARIANTS	85	75	65	40
<i>maximum achievable performance</i>				
air permeability	4	4	4	4
water tightness	9A	9A	8A	x
wind resistance	C5	C5	C4	A2
thermal transmittance *	1,1	1,1	1,4	x
acoustic performance	45 dB	45 dB	43 dB	x
glass thickness	58	50	39	x
tilt and turn (maximum capacity)	150	150	x	x

\* standard frame with Ug = 1,0 W/m²K

technical dr.  
p. 58

technical dr.  
p. 60

technical dr.  
p. 62

X = unavailable

## GEOMETRY AVAILABLE

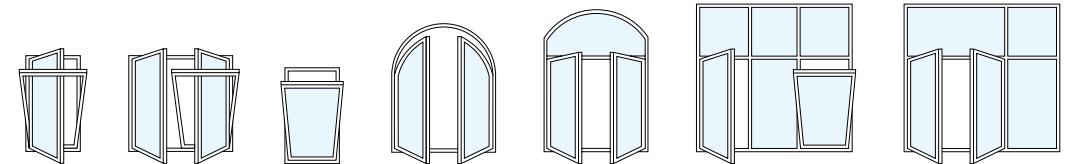

internal opening

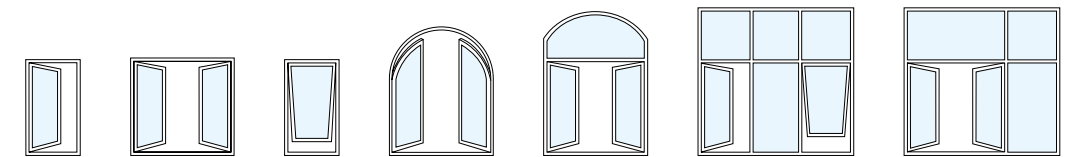

external opening



**OS2 75** burnished stainless steel  
external view



**OS2 75** burnished stainless steel  
internal view



**OS2 65** corten steel  
external view



**OS2 65** corten steel  
internal view



**OS2 40** painted pickled steel  
external view



**OS2 40** painted pickled steel  
internal view

# windows OS2 85

inward-opening sections

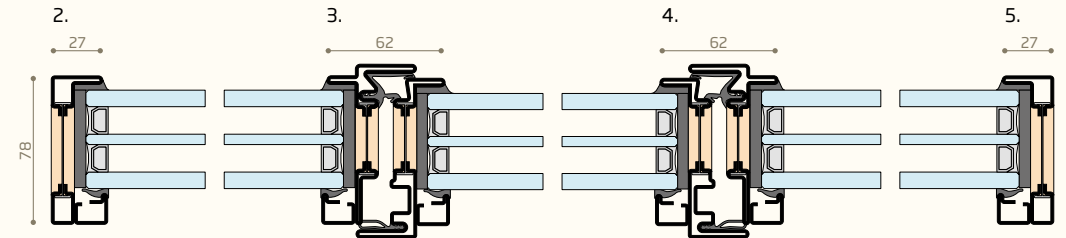
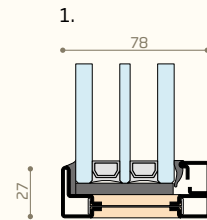
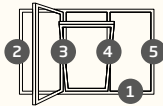
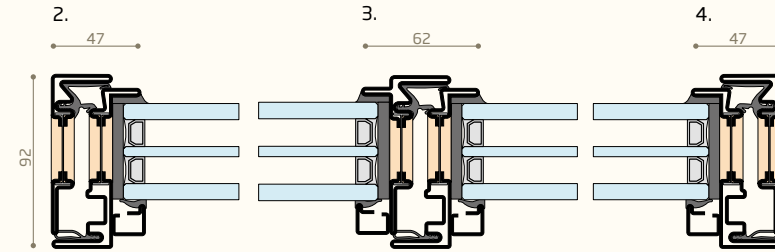
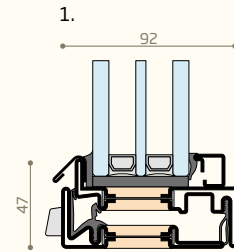
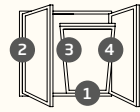

outward-opening sections

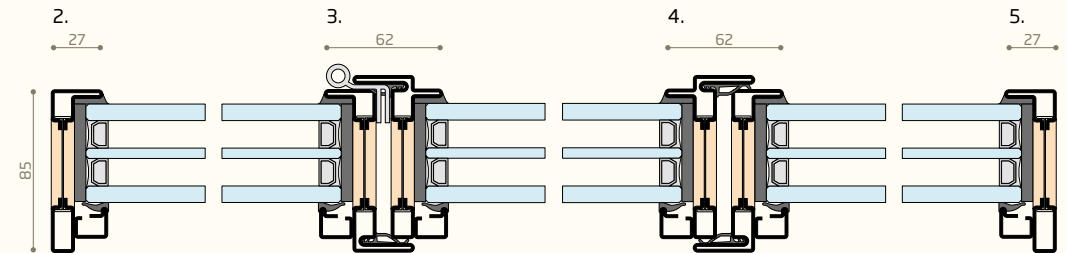
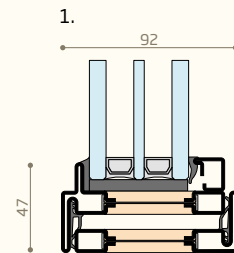
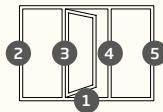
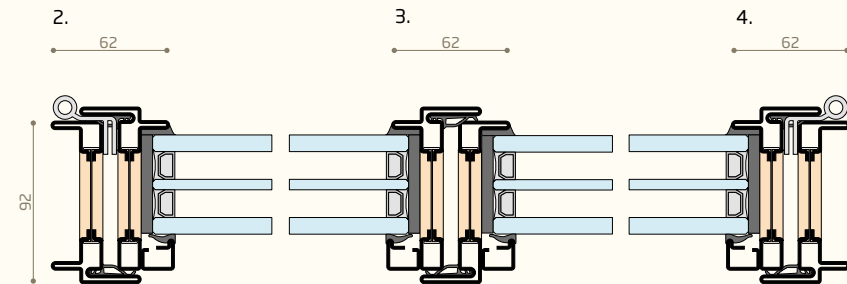
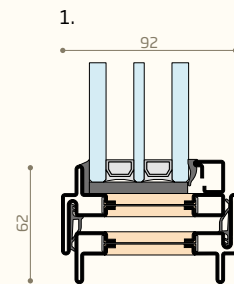
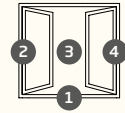



# windows OS2 75

inward-opening sections

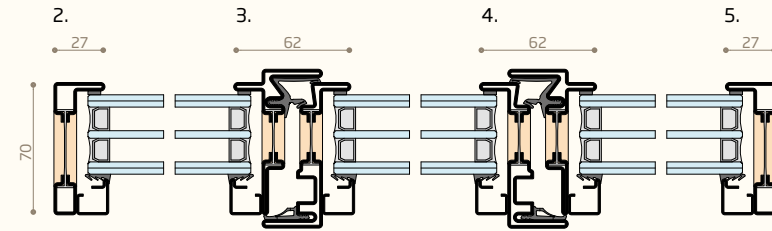
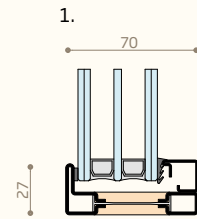
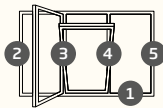
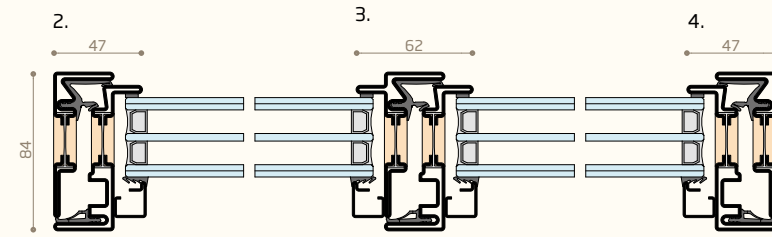
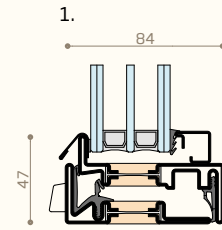
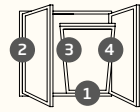

outward-opening sections

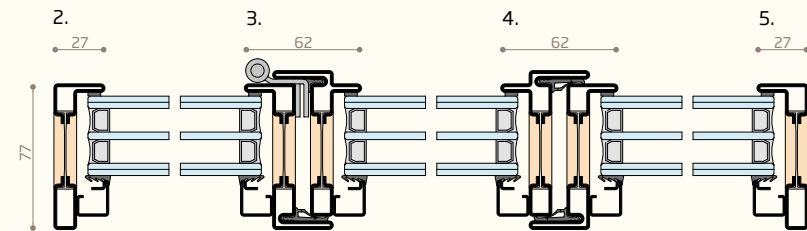
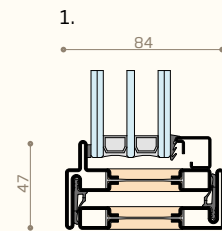
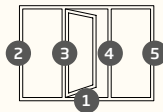
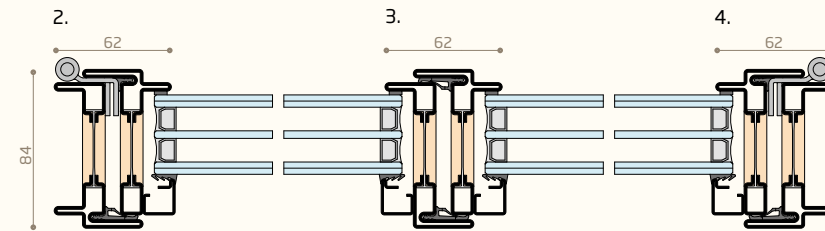
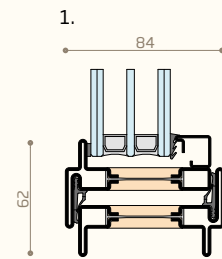
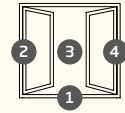

# windows OS2 65

inward-opening sections

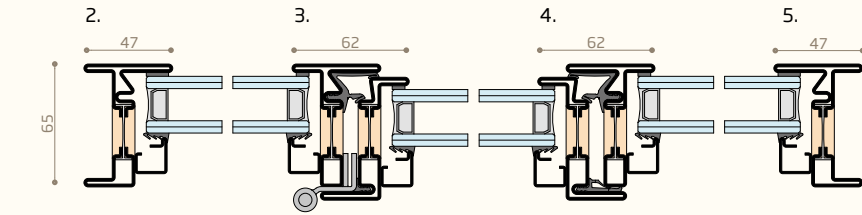
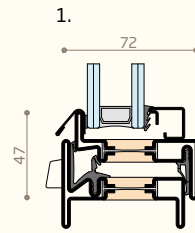
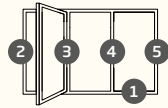
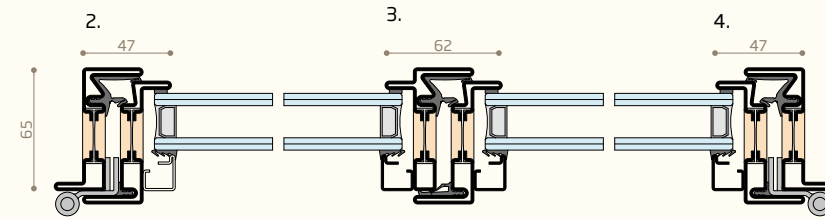
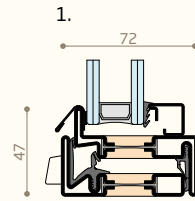
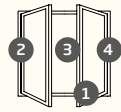

outward-opening sections

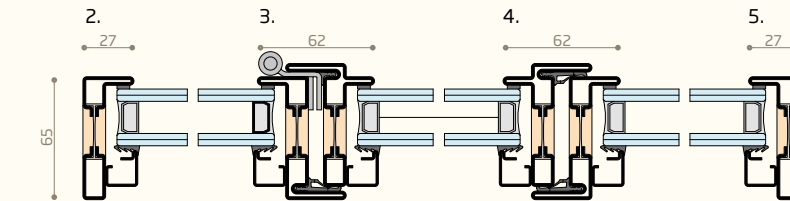
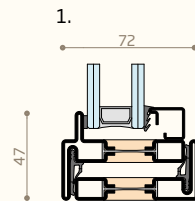
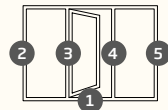
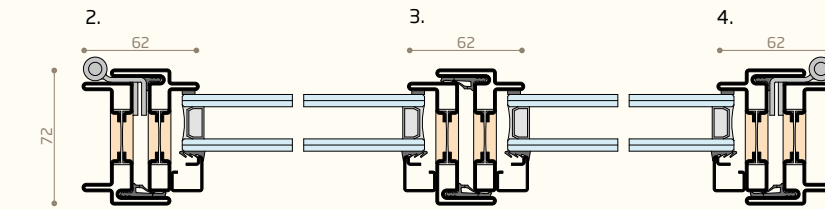
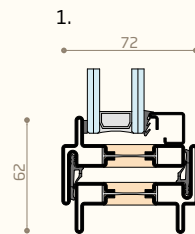
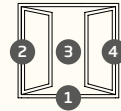



Fondaco dei Tedeschi - Venezia  
designer: Rem Koolhaas

# doors OS2

OS2 doors are made, for design continuity, with profiles that have the same dimension of the windows, lateral node is only 47mm wide and the central node 62 mm.

The hinges, a fundamental part of the functionality and the durability of the frame, have the same profile finishes.



VARIANTS	85	75	65	40
maximum achievable performance				
air permeability	4	4	4	4
water tightness	7A	7A	7A	x
wind resistance	B3	B3	B3	A2
thermal transmittance*	1,0	1,1	1,4	x
acoustic performance	x	x	x	x
glass thickness	58	50	39	x

\* standard frame with  $U_g = 1,0 \text{ W/m}^2\text{K}$

technical dr.  
p. 70

technical dr.  
p. 72

technical dr.  
p. 74

technical dr.  
p. 76

X = unavailable

## GEOMETRY AVAILABLE

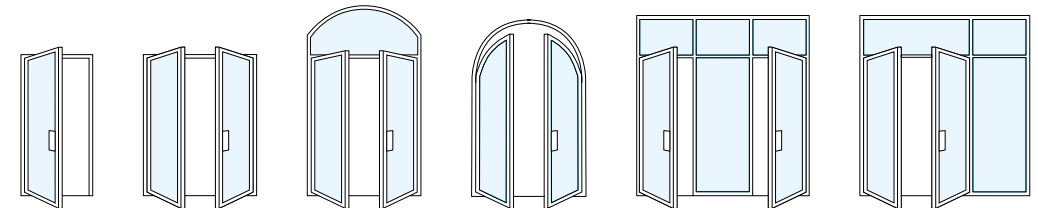

internal opening

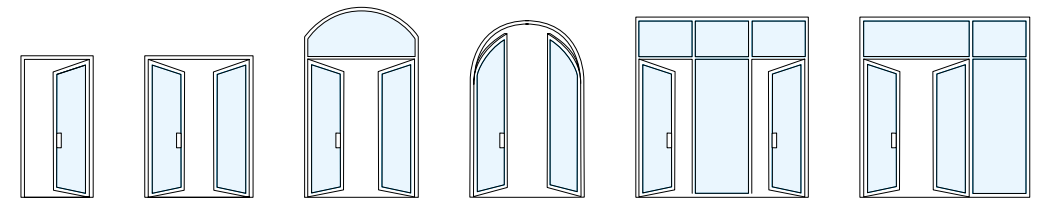

external opening



**podere Panico**  
designer: Fulvio De Rosa

# doors OS2 85

inward-opening sections

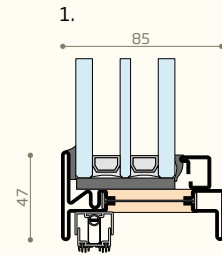
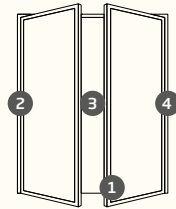
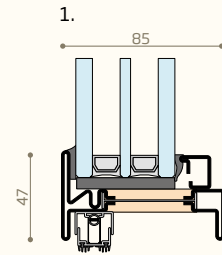
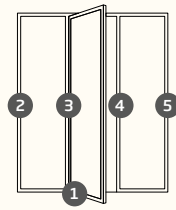

outward-opening sections

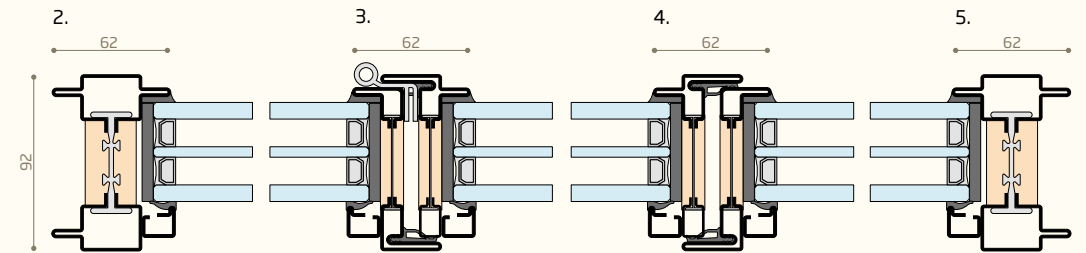
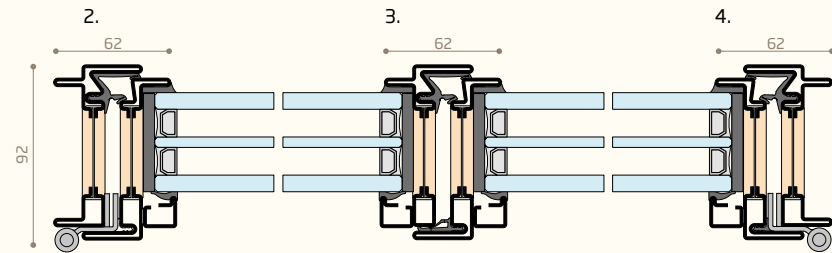
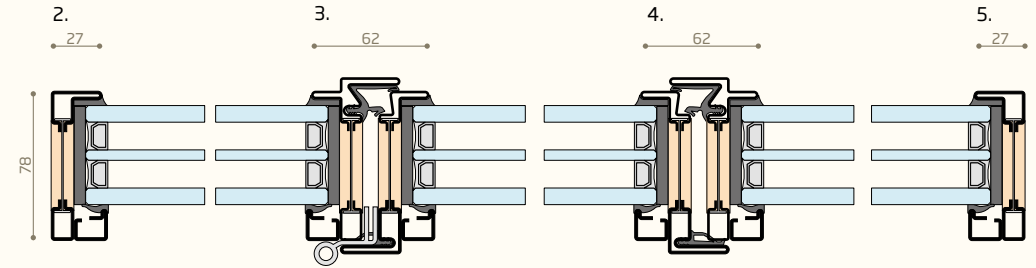
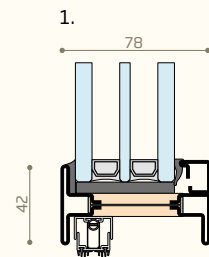
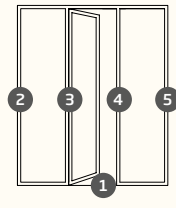

# doors OS2 75

inward-opening sections

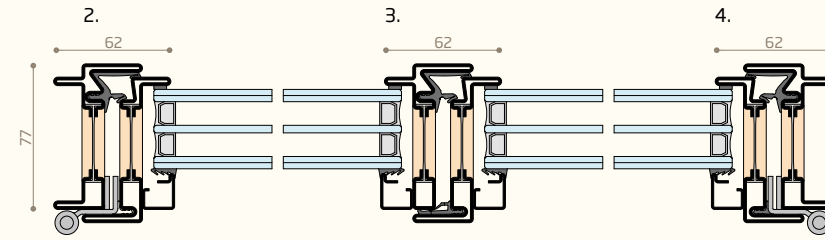
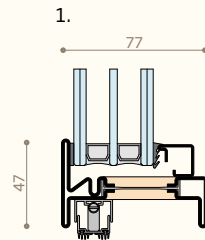
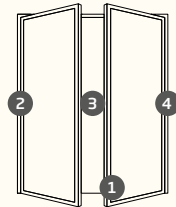
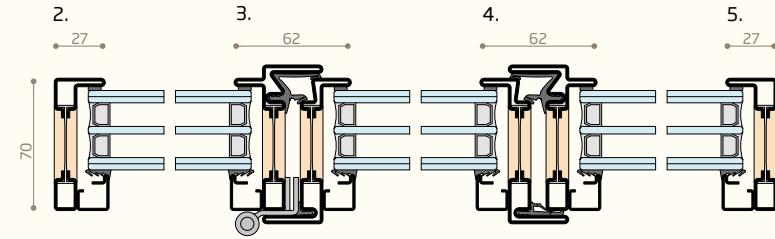
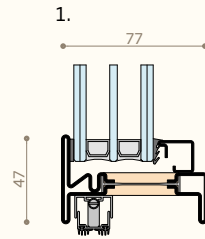
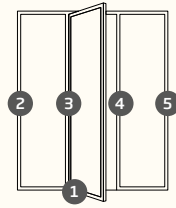

outward-opening sections

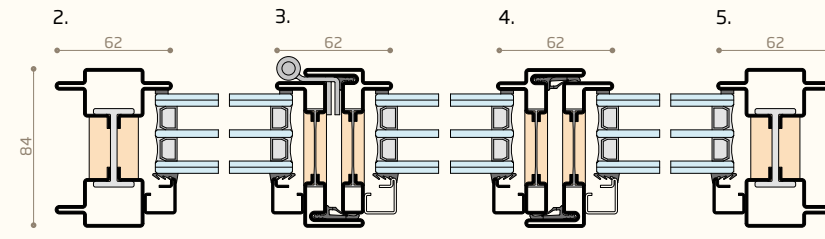
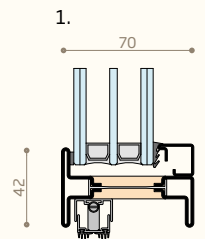
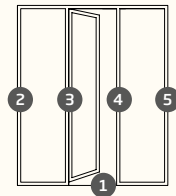

# doors OS2 65

inward-opening sections

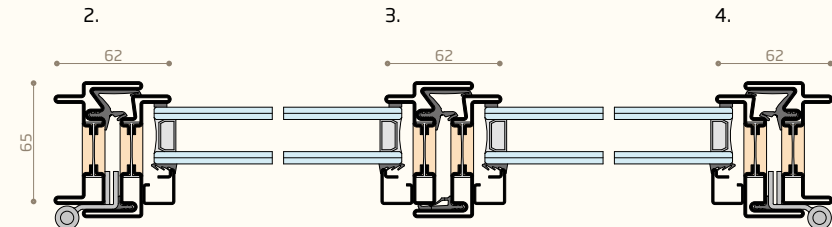
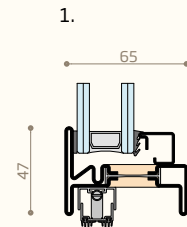
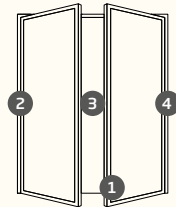
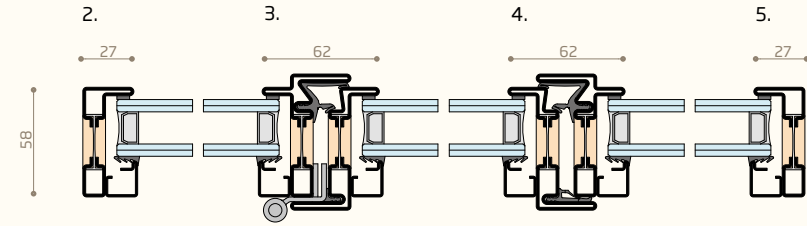
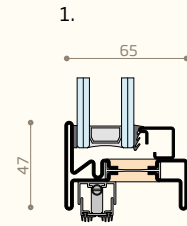
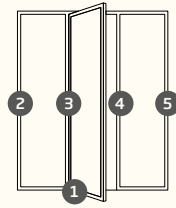

outward-opening sections

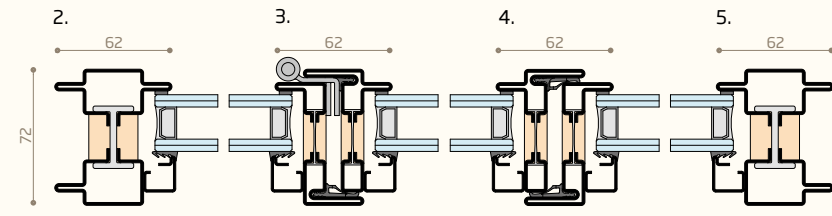
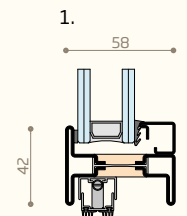
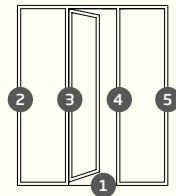



# doors OS2 40

inward-opening sections

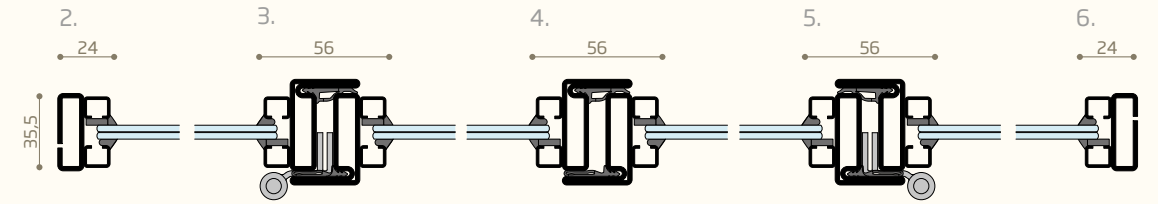
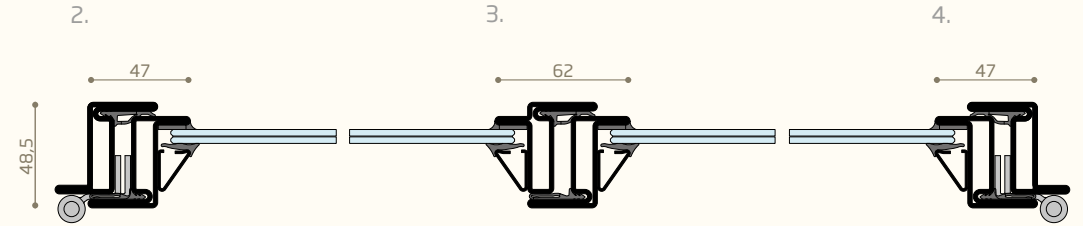
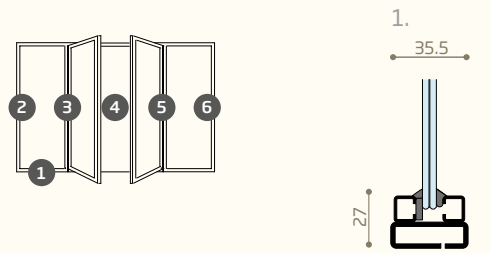
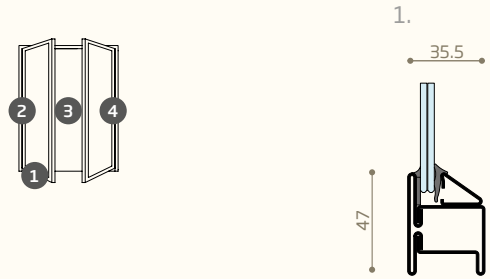

outward-opening sections

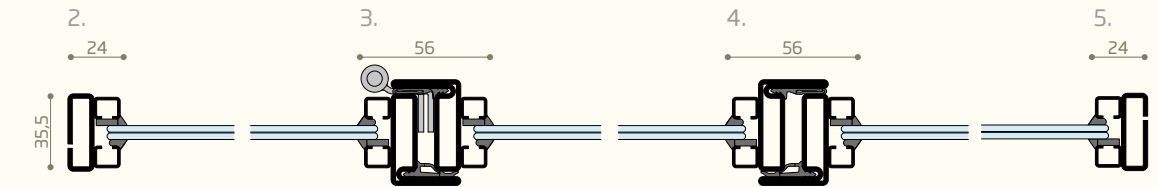
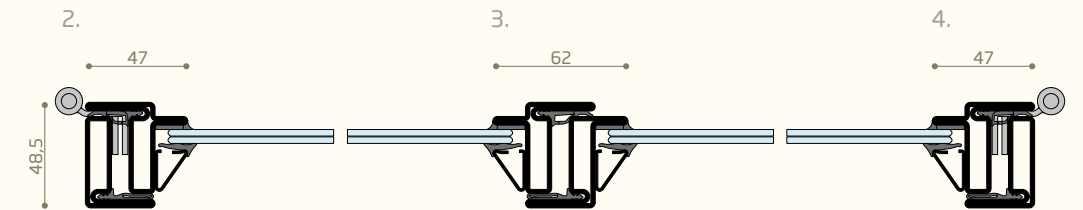
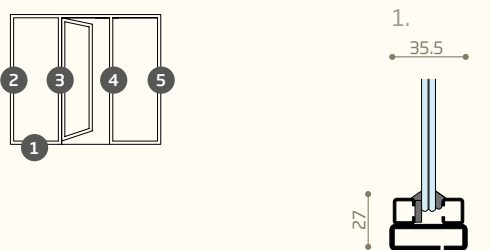
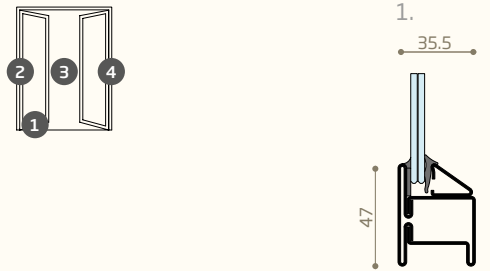



**Serre Reali - Venezia**  
designer: Alberto Torsello

# lift and slide OS2

The OS2 lift and slide doors find the elegance in quality materials and in the accuracy of profile design, constant on all the door perimeter with dimensions of 47 mm or 62 mm, to match the windows profiles respectively to one or two doors.

The movement of the door can take place with the traditional wheels or with the innovative magnetic levitation ØG "Zero Gravity", awarded with the Oscar of design, the "Compasso d'Oro".



In-depth analysis  
(catalog - slide)

VARIANTS	85	75	65	40
<i>maximum achievable performance</i>				
air permeability	x	4	x	x
water tightness	x	9A	x	x
wind resistance	x	B3	x	x
thermal transmittance*	x	1,3	x	x
acoustic performance	x	x	x	x
glass thickness	x	46	x	x
carried with traditional system on wheel	x	400	x	x
carried with with zero gravity system	x	1000	x	x

\* standard frame with  $U_g = 0,7 \text{ W/m}^2\text{K}$

technical dr.  
p. 84/86

x: unavailable



## GEOMETRY AVAILABLE

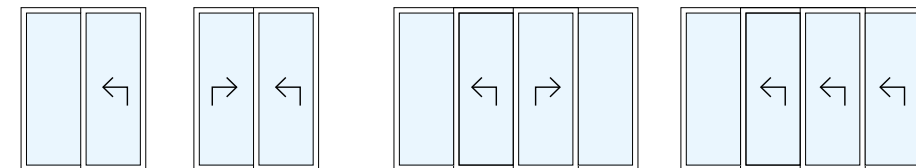

online opening

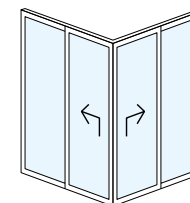

angular opening



**OS2 75 AS** burnished brass  
internal view

**OS2 75 AS** burnished brass  
external view

# lift and slide OS2 75

lift and  
slide doors  
sections

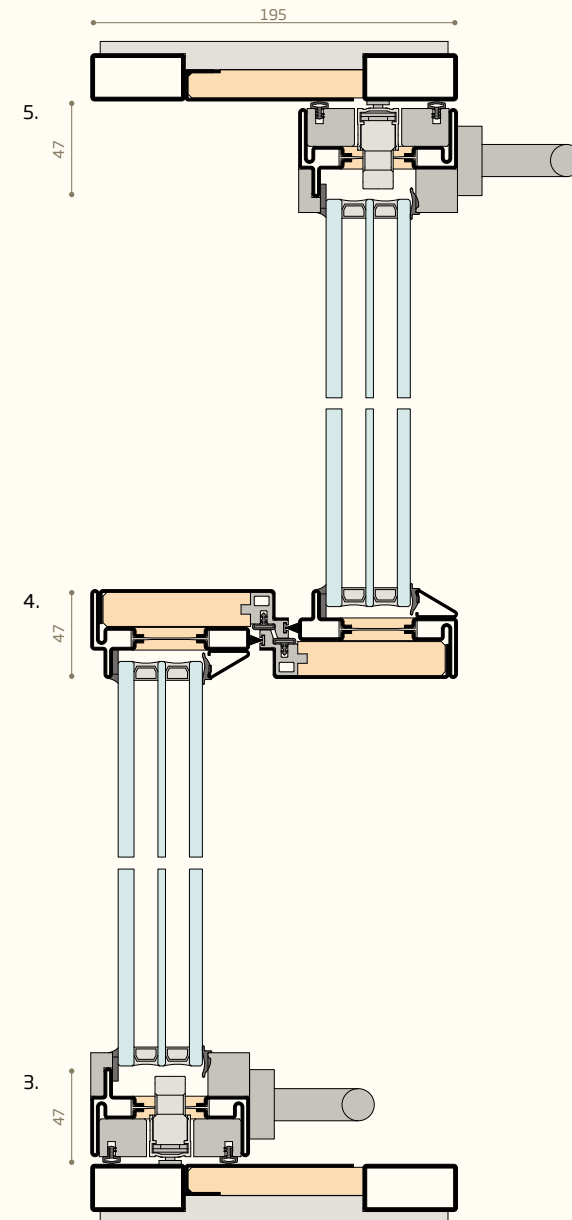
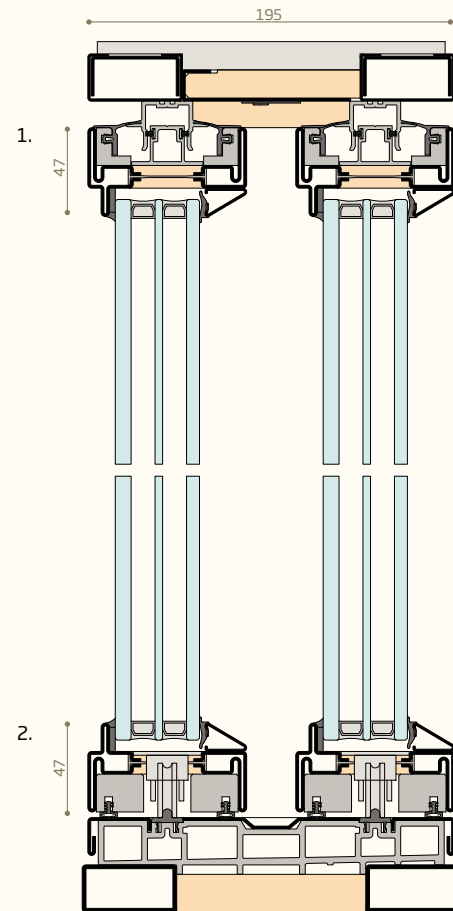
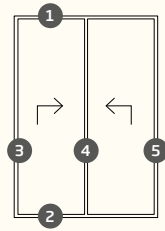

# ØG lift and slide OS2 75

lift and slide  
door sections  
with magnetic  
levitation

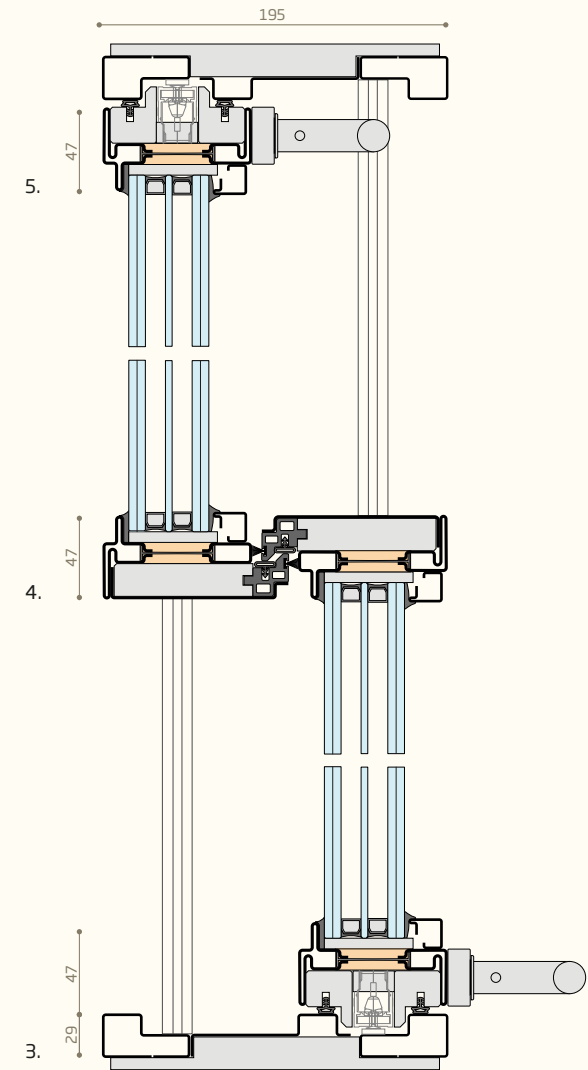
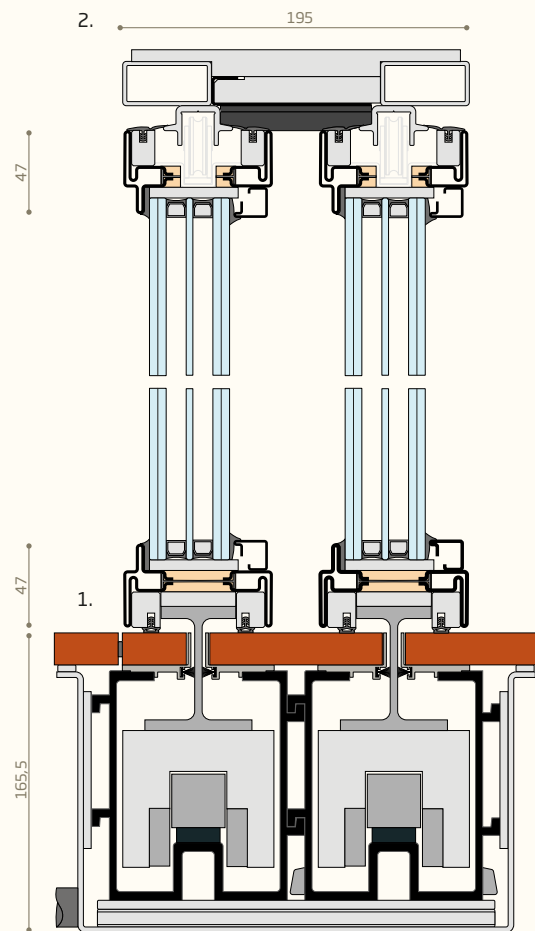
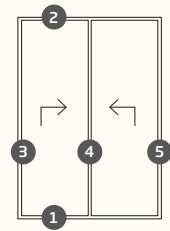



**villa Alpago**  
designer: DTACC

# pivot OS2

Elegant and spectacular, the OS2 pivot with its big dimensions and its minimal profiles redefine the relation between window and frame and also between lightweight and dimensions.

The OS2 pivot is set up as a refined solution that takes from tradition its innovation, repurposing itself with valuable metals, high sealing and insulation performance and reduced visible sections: only 62 mm consistent in all the window perimeter.



In-depth analysis  
(catalog - pivot)

VARIANTS	85	75	65	40
<i>maximum achievable performance</i>				
air permeability	x	4	4	x
water tightness	x	9A	7A	x
wind resistance	x	C5	C5	x
thermal transmittance*	x	1,1	1,4	x
acoustic performance	x	x	x	x
glass thickness	x	50	39	x
maximum vertical pivot capacity	x	350	100	x
horizontal pivot maximum capacity	x	250	100	x

\* standard frame with  $U_g = 1,0 \text{ W/m}^2\text{K}$

technical dr.  
p. 94

technical dr.  
p. 96

x: unavailable



## GEOMETRY AVAILABLE

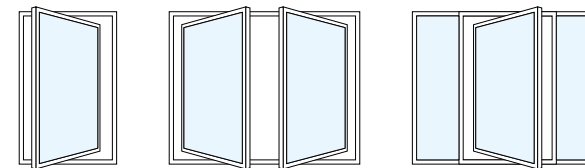

vertical pivot window

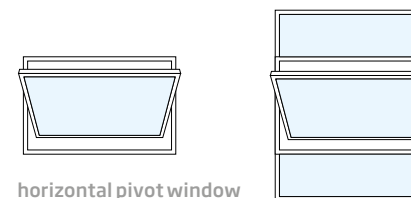

horizontal pivot window





# pivot OS2 75

horizontal  
pivot  
sections

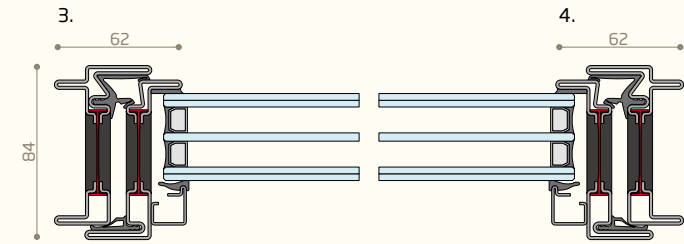
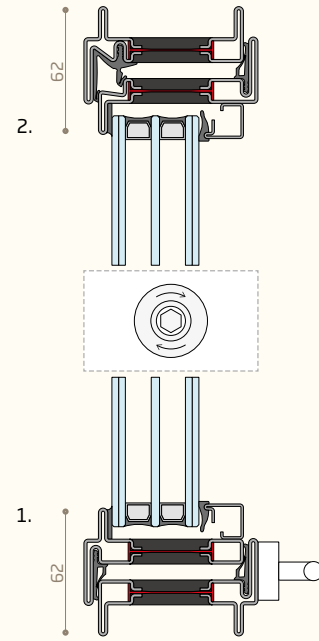
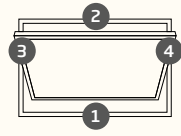

vertical  
pivot  
sections

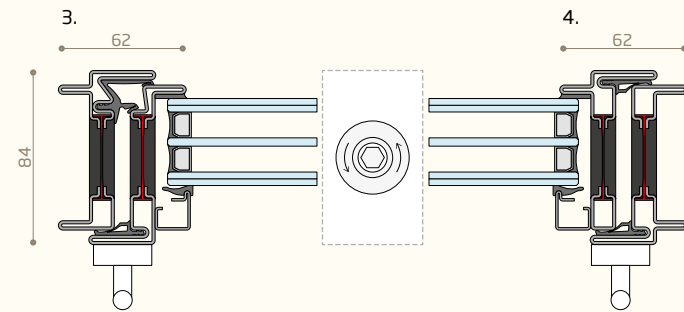
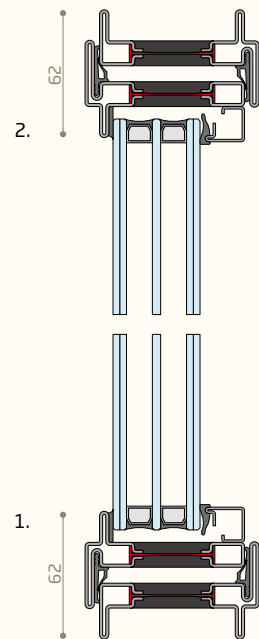
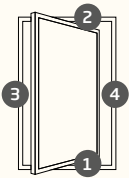

# pivot OS2 65

horizontal  
pivot  
sections

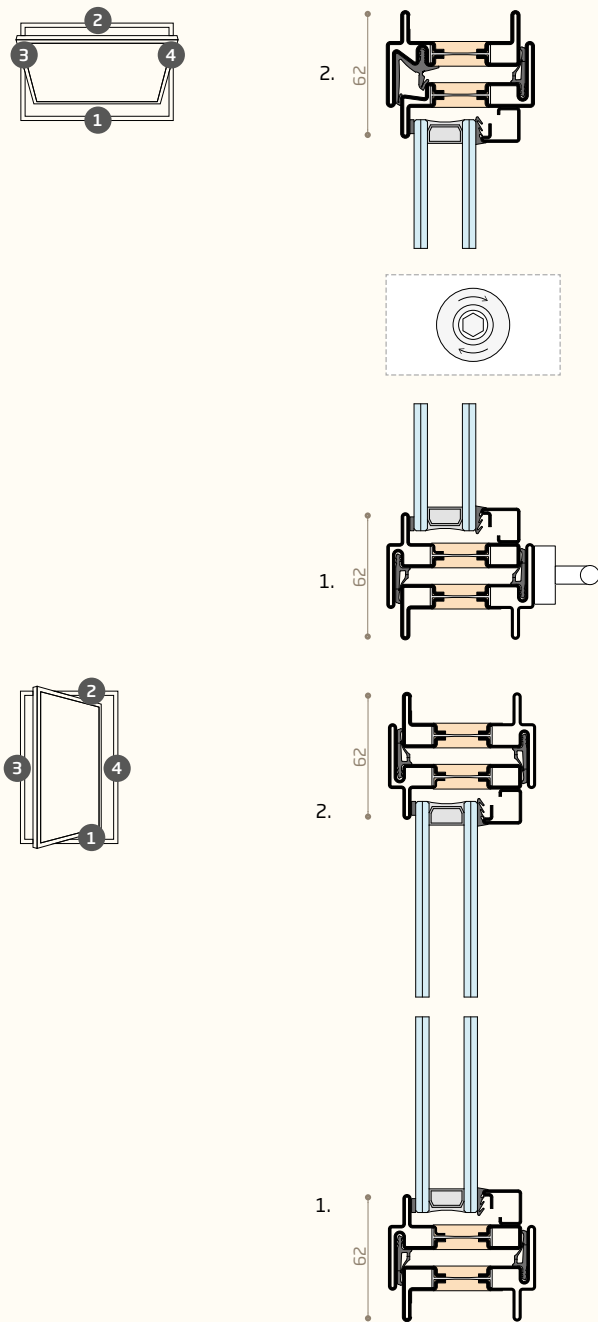

vertical  
pivot  
sections

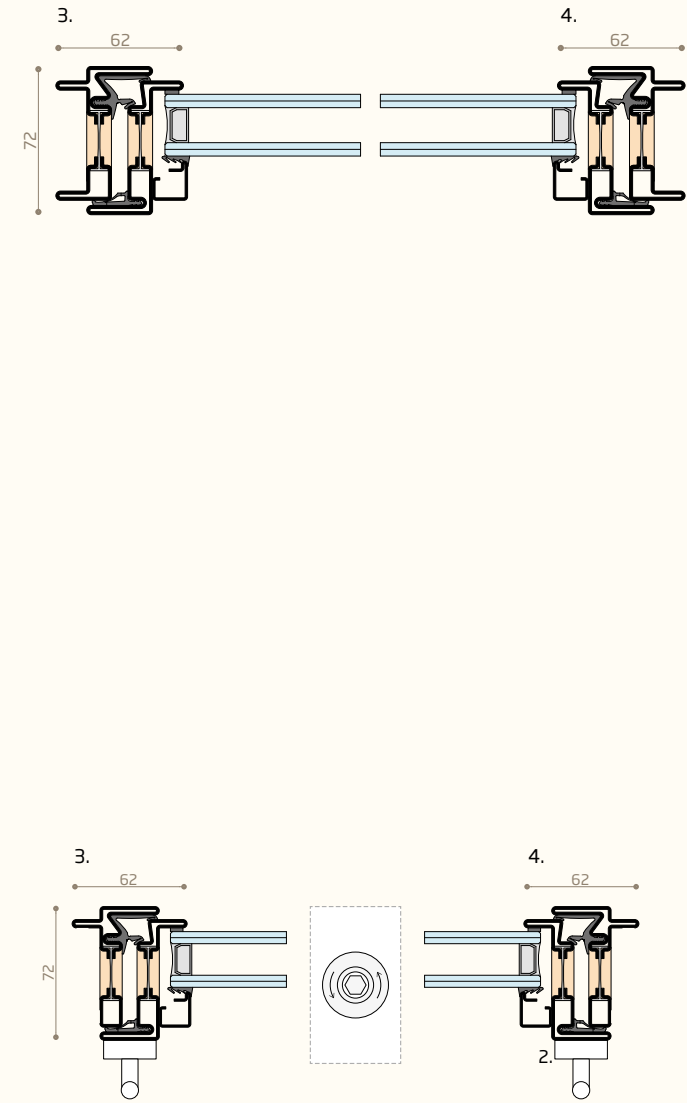



casolare crete Senesi

# folding OS2

The folding opening allows to create versatile environments, which open completely to the outside.

OS2 folding solves the aesthetic and functional shortcomings of traditional windows, by offering a system with high insulation and sealing performance with visible nodes always equal to each other and of only 62 mm wide, recessed upper and lower sliding rails and high-quality profile materials.



VARIANTS	85	75	65	40
<i>maximum achievable performance</i>				
air permeability	x	4	x	x
water tightness	x	5A	x	x
wind resistance	x	B3	x	x
thermal transmittance*	x	1,0	x	x
acoustic performance	x	x	x	x
glass thickness	x	40	x	x

\* standard frame with Ug = 0,7 W/m²K

technical dr.  
p.104/106

x: unavailable

## GEOMETRY AVAILABLE

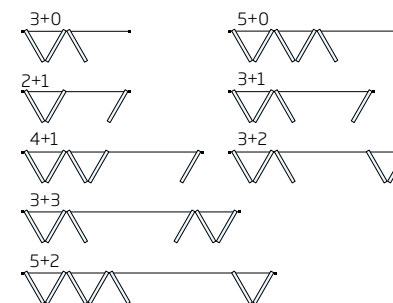

internal opening

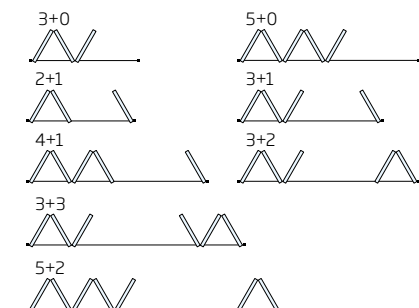

external opening



**OS2 75 LB** corten steel  
internal view



**OS2 75 LB** corten steel  
internal view

# folding OS2 75

folding doors sections with 4 inward opening

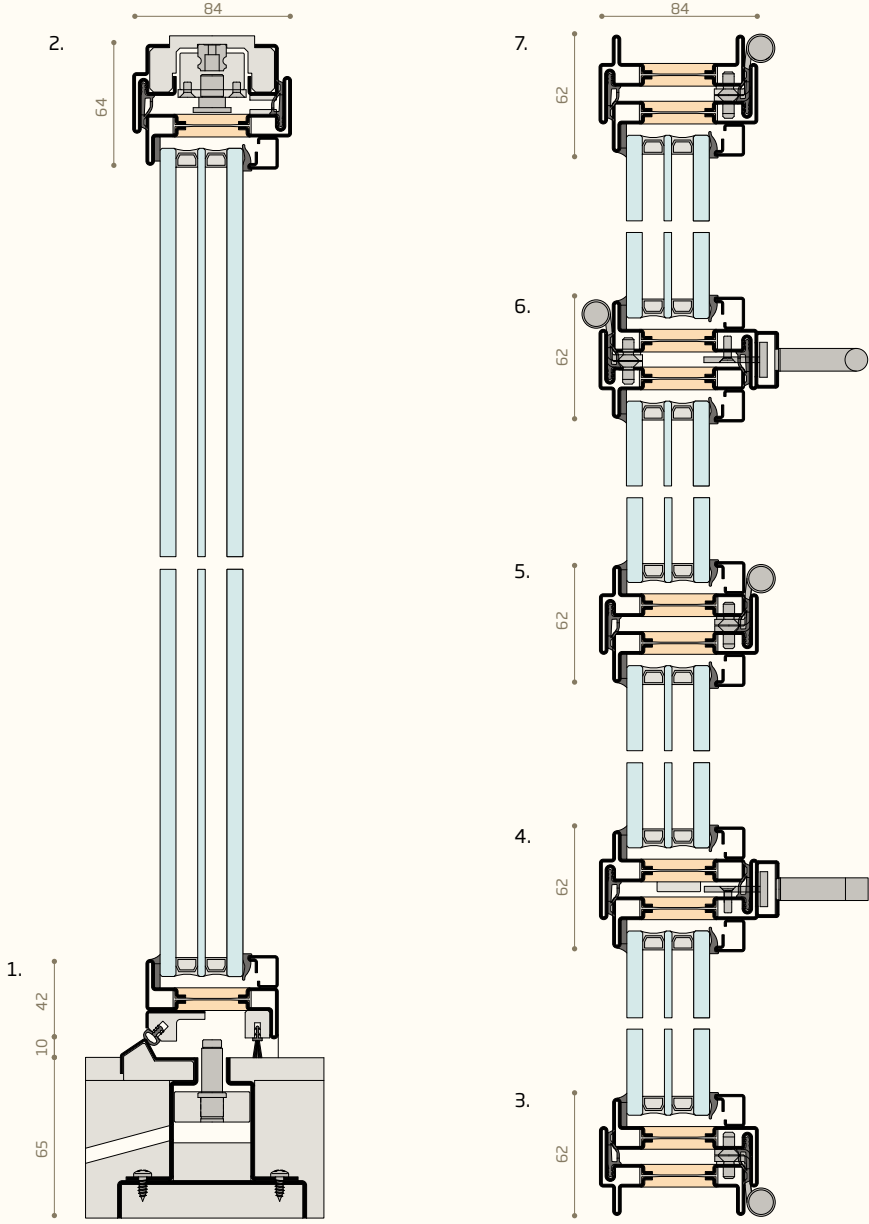
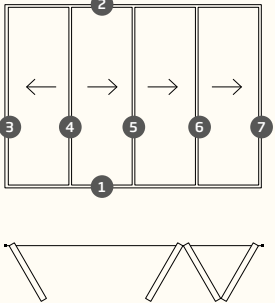

# folding OS2 75

folding doors sections with 4 outward opening

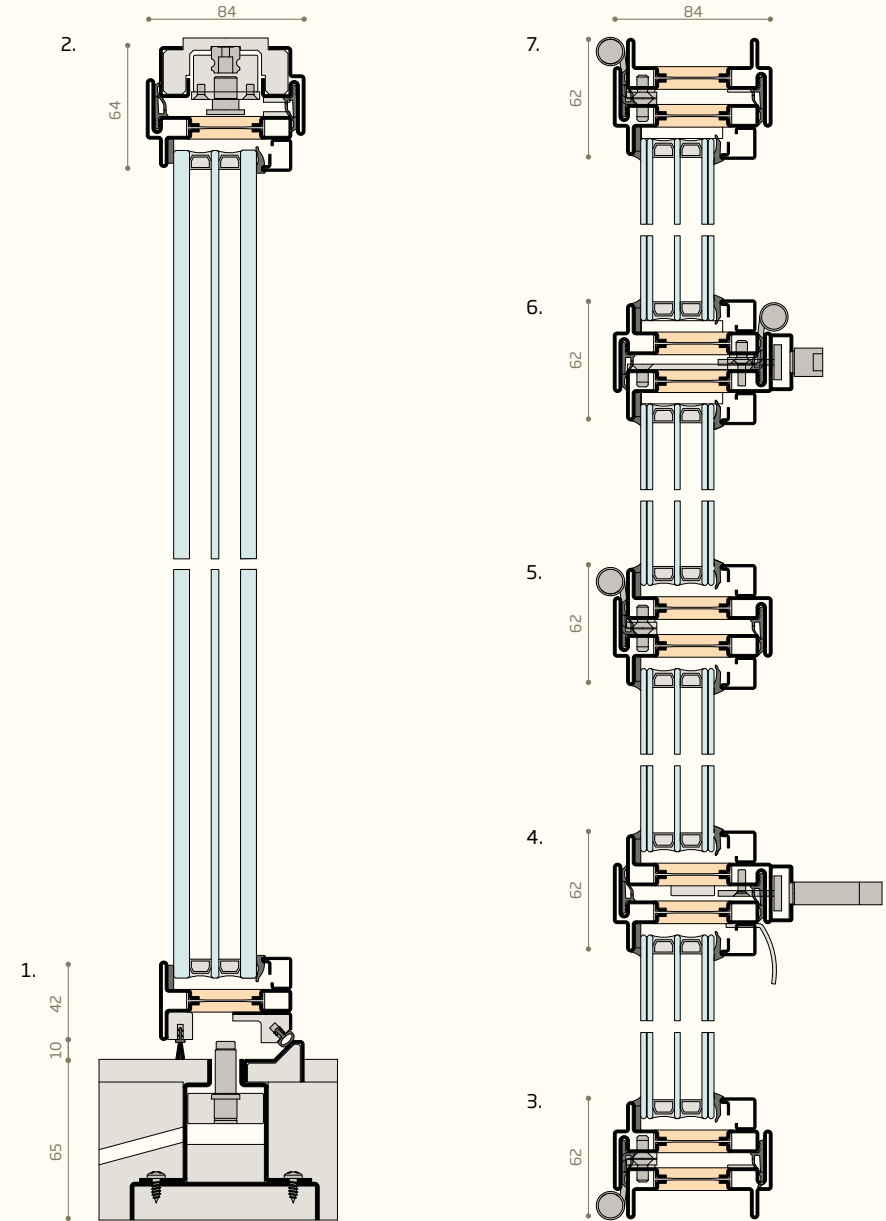
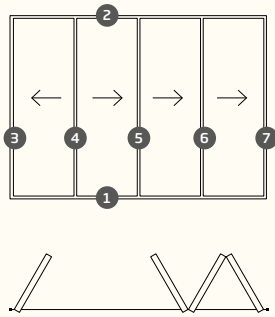





**uffici One Works**  
designer: One Works

# anti-burglary OS2

It is in the nature of the metal, the raw material of Secco products, the ability to resist shocks and deformations, for this reason even the small sections of OS2 feel robust enough to allow the creation of windows with minimal profiles and high anti-burglary performance up to class RC3.

The OS2 burglar-proof windows frames are made with valuable finish like stainless steel galvanized steel and the new finishes for RC, Ottone and Corten.



In-depth analysis  
(catalog - anti-burglary)

## VARIANTS

85    75    65    40

maximum achievable performance

	85	75	65	40
anti-burglary class 2	si	si	si	x
anti-burglary class 3	si	si	x	x

technical dr. p. 114    technical dr. p. 116    technical dr. p. 118

x : unavailable

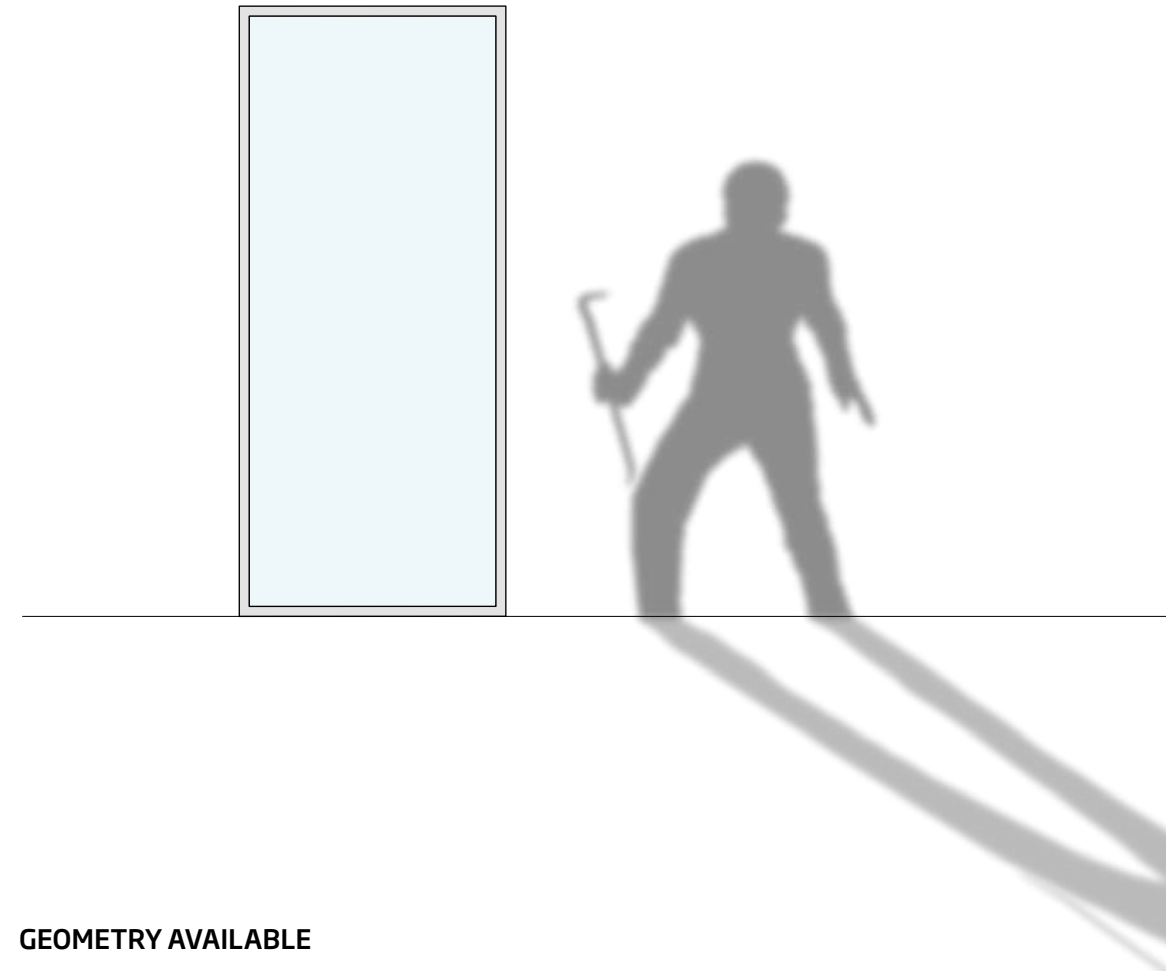

## GEOMETRY AVAILABLE

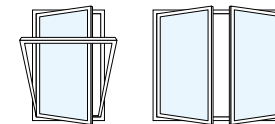

inward opening windows

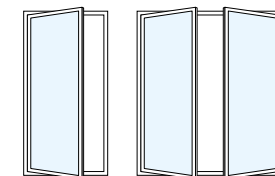

inward opening doors

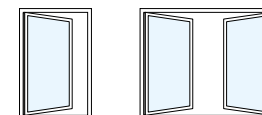

outward opening windows

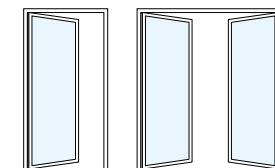

outward opening doors

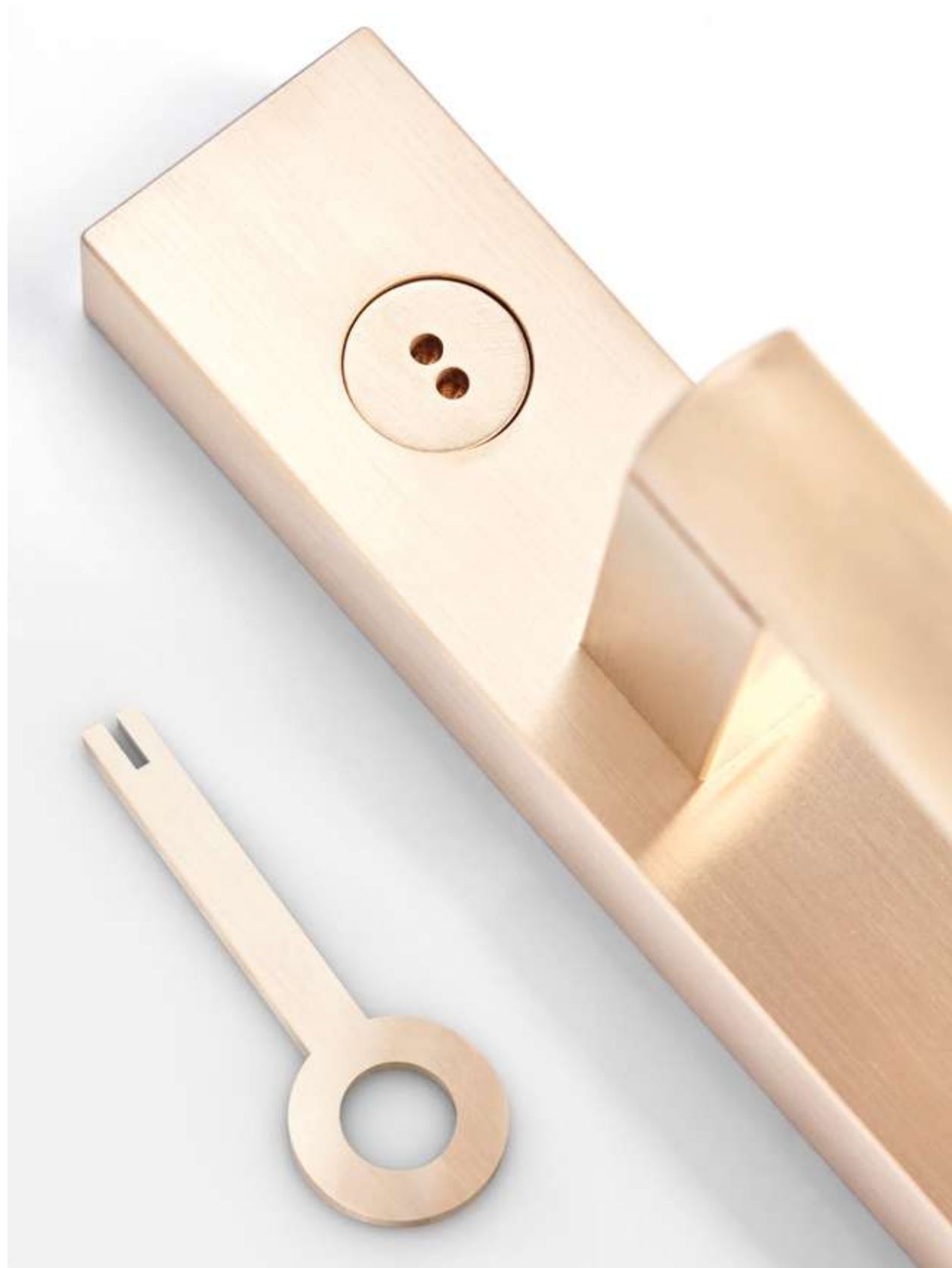

# anti-burglary OS2 85

window sections  
two inward  
opening

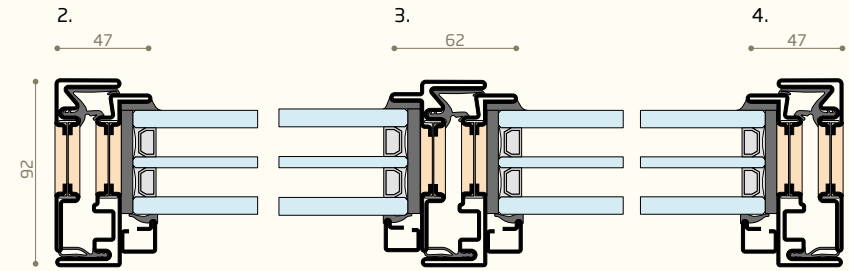
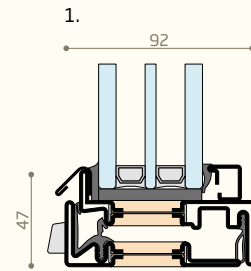
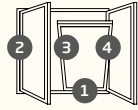

window sections  
two outward  
opening

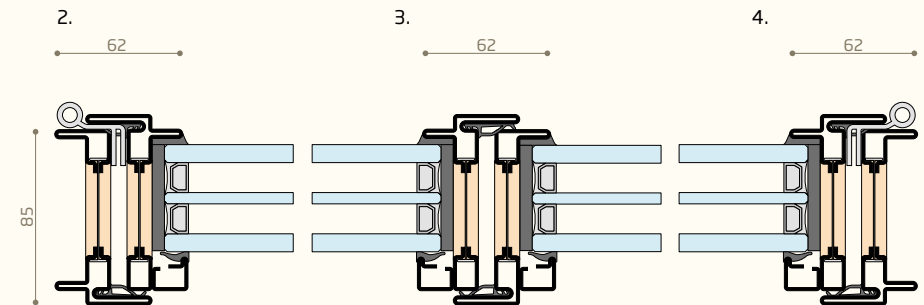
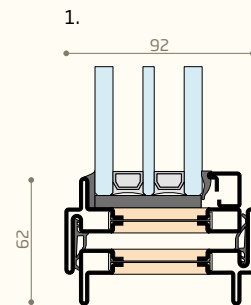
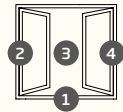

# anti-burglary OS2 75

window sections  
two inward  
opening

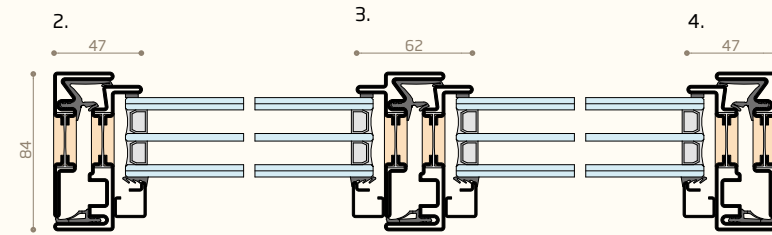
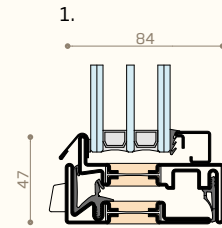
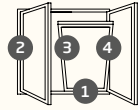

window sections  
two outward  
opening

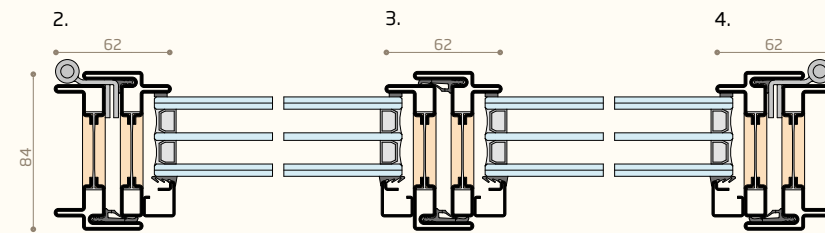
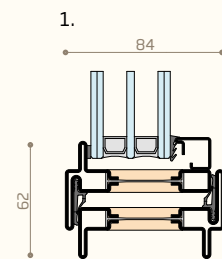
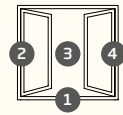

# anti-burglary OS2 65

window sections  
two inward  
opening

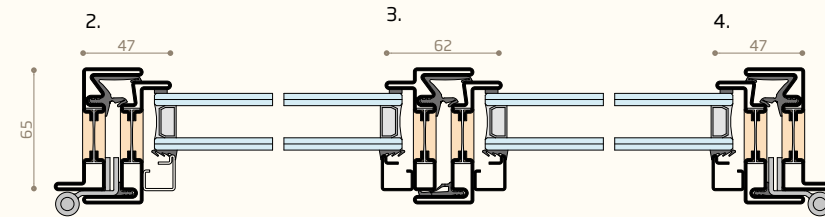
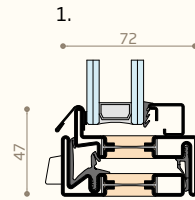
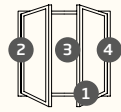

window sections  
two outward  
opening

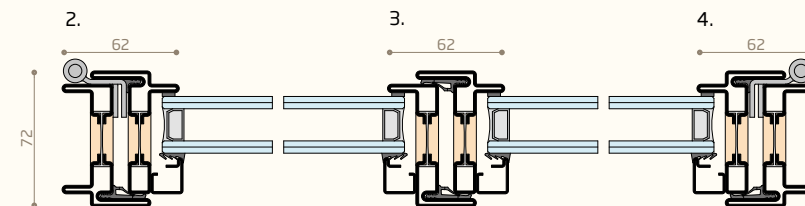
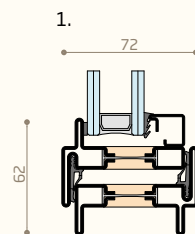
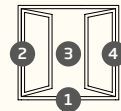



**flat in Milan**  
designer: Luca Bombassei





# handles

Elegant and discreet complements in harmony with the essential lines of the window, handles are realized with the same valuable materials and finish of profiles. The handles are available in two design family: Vitruvio and cariglione Raffaello.

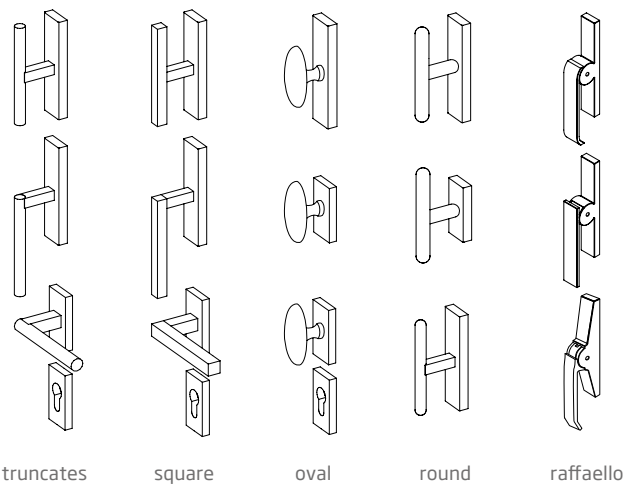

# glazing beads

Little profiles to secure the glass to the frame, glazing beads are elegant elements that complete and makes unique the window design. They are available in essential geometric shapes, square, triangle, L.

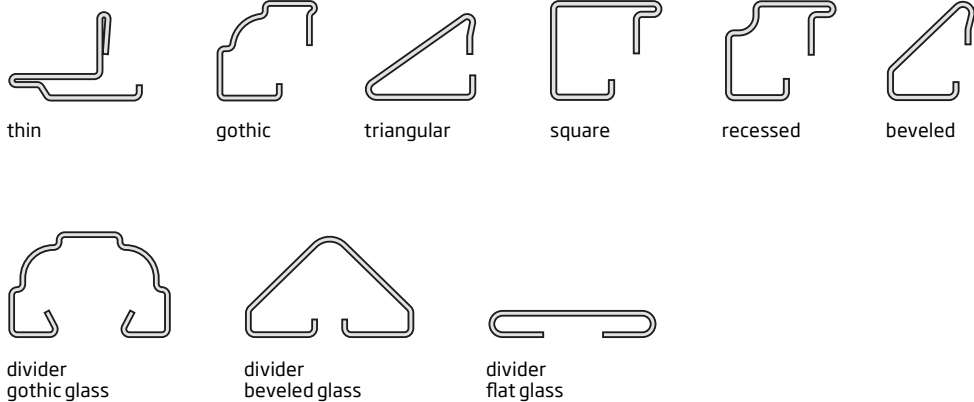

# *hinges*

Thin, light and small but able to ensure the handling of large heavy doors, hinges make up the design of the frame with elegance, they are made with the same material and finish of the profiles and they can be both technological devices and plastic elements.

The hinges are adjustable and have been tested by strict regulations that certify the quality and durability.

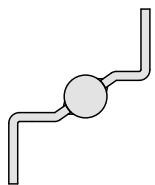

two-wing  
Ø 12 mm

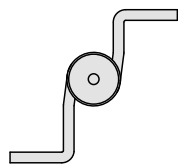

three-wing  
Ø 15 mm



welded  
Ø 13 mm



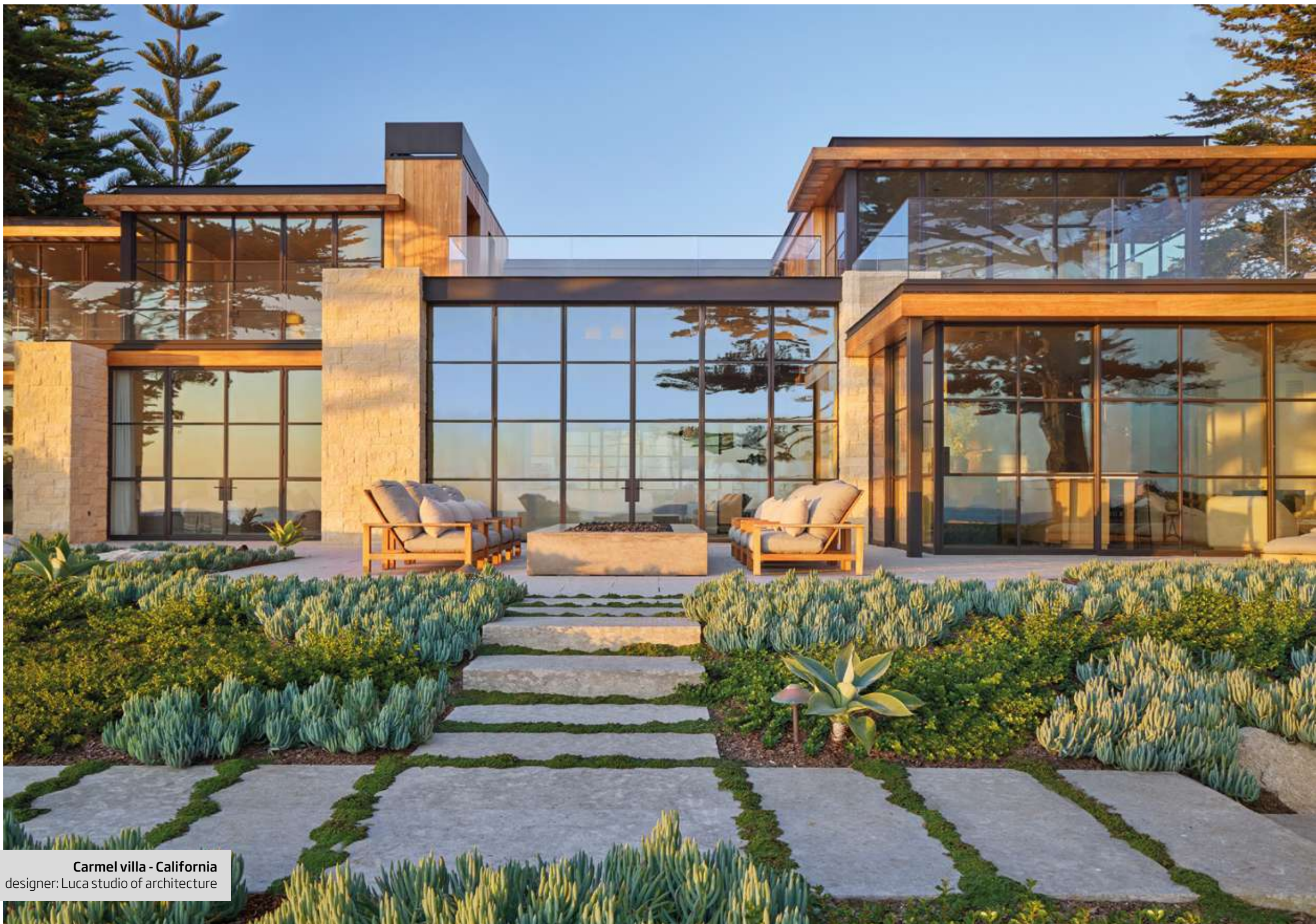

**Carmel villa - California**  
designer: Luca studio of architecture



Secco Sistemi is an Italian brand expression of innovation and design awarded "Compasso d'Oro".

For 70 years it contributes to the evolution of window engineering: it invents systems and profiles that become reference models for the industry and Secco continues to improve them, to interpreting projects and trends in contemporary architecture and restoration.

Secco Sistemi produces every year 1 million linear meters profiles in over 300 models that allow to realize 35 different types of openings in 4 precious metals - galvanized steel, stainless steel, corten steel and brass - and in 9 finish. It adapts its industrial capacity to the artisanal sensibility to solve and produce more than 50 special projects every year.