

SlimLine 38

Doors



Reynaers
Aluminium

Windows.
Doors.
Façades.

Together for better

www.reynaers.com

Ultra-slim and elegant design

With SlimLine 38, you have always got a slender door solution at hand. The ultraslim system comes in multiple design variants and offers refined quality in every detail.

Perfect for both minimalistic new-builds and renovation projects, the timeless steel look design blends perfectly with any architectural style.

Variants such as balcony doors or terrace doors with optional triple glazing and burglarproof performance (RC2 / PAS 24), help you reach today's safety and energy efficiency standards.

In fact, SlimLine 38 is both an elegant and eco-friendly system. Experience low-carbon, Cradle To Cradle® certified quality whenever you open or close this aluminium door solution.



Futureproof and durable product.

As less material is needed to create the slender yet sturdy doors, SlimLine 38s carbon footprint is remarkably low. Moreover, the futureproof doors are 100% recyclable and feature high-insulation variants to meet all of your low-energy building needs. Choose ultraslim design without compromising on quality nor comfort.

Slim steel-look design.

SlimLine 38 doors combine timeless steel-look design with all the benefits of aluminium profiles. Outstanding performance, slim aesthetics, and fast production speed: it is the perfect solution for all kinds of (renovation) projects. The Classic and Ferro design variants, together with the system's various opening types, allow you to add a personal touch to your choice of high-quality joinery.

Crisp, high-quality finishing in every detail.

High quality design is most visible in the finest of details. For SlimLine 38, this means all hardware, including hinges and drainage options, is subtly concealed inside the ultraslim profiles. What is more, the door system comes with multiple threshold solutions to combine elegant design with pure practicality. Enjoy real show-stopping craftsmanship with refined doors of up to 3 metres in height.

SlimLine 38 Doors General

Possible vent sizes (mm)

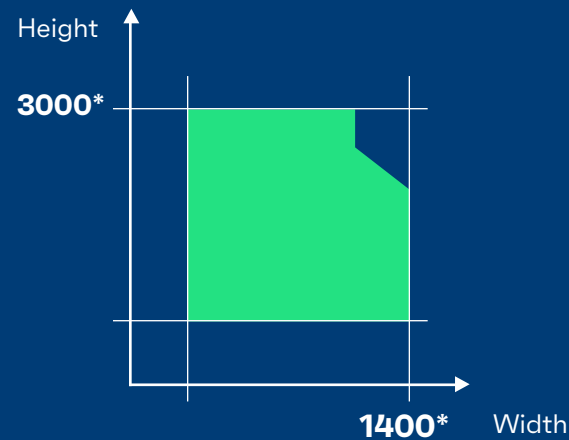

*Max dimensions depend on multiple parameters including wind load requirements and glass type choice.

Possible vent weights (kg)



Turn door

130

Visible dimensions (mm)

Inward opening door

1	Min. frame width	38
2	Min. vent width	21
3	Frame depth	76 or 99
4	Vent depth	86
5	Glass thickness	Up to 55

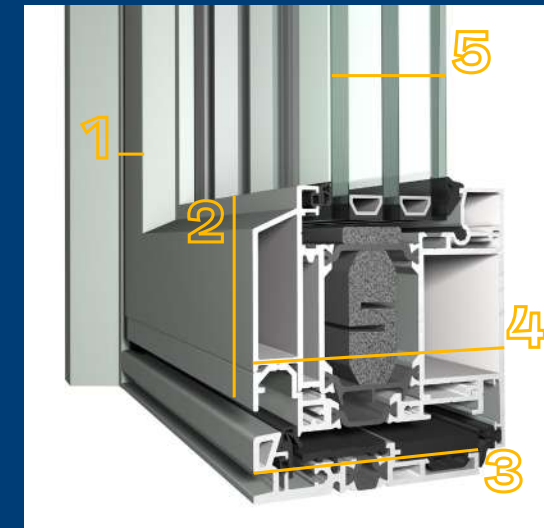

SlimLine 38 Doors Variants

SlimLine 38 Terrace Door

Thermal value - Uf (W/m²K)	Down to 1.6
Water tightness	9A (600 Pa)
Wind load resistance	C3 (1200 Pa)
Burglarproof	RC2 (EN 1627)



SlimLine 38 Zero Threshold Door

Thermal value - Uf (W/m²K)	Down to 1.6
Water tightness	-
Wind load resistance	-
Burglarproof	-



SlimLine 38 Entrance Door

Thermal value - Uf (W/m²K)	Down to 1.6
Water tightness	5A (200 Pa)
Wind load resistance	C3 (1200 Pa)
Burglarproof	RC2 (EN 1627) / PAS 24



More variants can be found on our website...

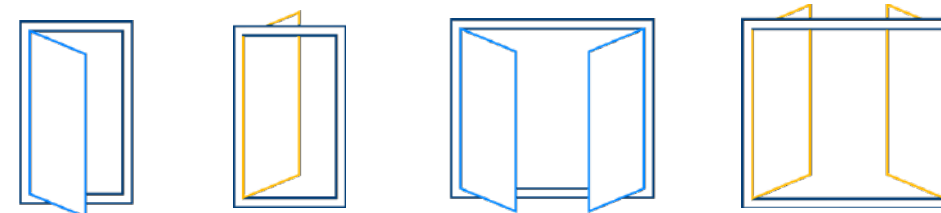

SlimLine 38 Doors Options



Concealed drainage

Thanks to this concealed drainage solution, you no longer need plastic cover caps to hide drainage holes. As a result, you always enjoy clean lines, minimalistic design, and excellent performance as the water flows away.



Panic solution

In some public buildings, a quick and safe escape route should always be available. These doors are equipped with anti-panic technology to guarantee secure passage in dangerous situations.



Low threshold

By reducing the height of the threshold, you can offer clear access at all times. Limit tripping hazards while establishing a clean and attractive look for your door.



Zero threshold

Creating inviting entryways and exits without boundaries has never been easier. This elegantly hidden threshold solution is the ideal match for your wheelchair-friendly building project, even with continuous flooring.



Design

You recognise minimalistic SlimLine 38 doors by their elegant and ultraslim look. Whether you choose its Classic, Ferro, or Functional design variant, the slim yet sturdy doors always create an aesthetic entryway for any building. The most recent update features an ultraslim door variant with an elegant in-glass lock plate. It is our slimmest vent profile in our entire door systems range.



Sustainability

SlimLine 38 doors are always a responsible choice. The Cradle To Cradle® certified system has a high insulation variant and features ultraslim profiles which require less aluminium to make. As a result, the doors have a lower embodied carbon level than most competitor systems. What is more, aluminium is 100% recyclable, which means you can re-use it an infinite amount of times without loss of quality.

Get in touch

Interested or looking for more in-depth technical information? Contact your Reynaers Aluminium representative for more information or scan the QR code to visit our website.



Smart Buildings Product Brochure



Reynaers
Aluminium

Windows.
Doors.
Curtain Walls.

Together for better

www.reynaers.com

Table of contents

Introduction	3
Automated locking systems for doors	4-17
Automated locking systems	5
FUHR multitronic	6
FUHR autotronic	10
Intelligent locking options	12
Access control for automated locks	13
dLine fingerprint scanner	15
Keypads	16
Technical overview	17
Automated sliding doors	18-22
Concealed motorised solutions	19
HiFinity	20
MasterPatio	21
ConceptPatio 155 (-LS)	22
Access control for sliding doors	23
Element controller	23
Natural ventilation	24-25
E-Invisitop	24
Ventilation vent	25
Magnetic contacts	26





Introduction

Life, more comfortable than ever

Reynaers Aluminium has always been synonymous with quality materials, cutting-edge design and lifelong comfort. With the seamless integration of smart building solutions into our products, we now add top-notch smart technology to the mix to help make your life more comfortable than ever.

Our windows and doors are compatible with the industry's leading smart building systems. Together, they provide users with a new level of comfort, security and peace of mind. Thanks to a range of intelligent solutions, our windows and doors do the work for you at the push of a button. No need to worry about keys anymore: the smart system allows you to manage access to your home or building through a fingerprint scanner or app. Moreover, you can check whether doors and windows are properly closed from a distance and have packages delivered inside safely while you are away.

Automated locking systems for doors

Opening doors at the touch of a button

Modern living and working environments require the highest levels of convenience, energy conservation and security. In the buildings of the future, doors and windows will play an important role in achieving these goals. That is why, together with our partners FUHR and ekey, we now offer some of the industry's most cutting-edge locking and access control systems.

Thanks to smart fingerprint scanners, keypads and/or home automation systems, users will never need a physical key again: doors can be opened at the touch of a button for quick and easy access.



Automated locking systems

Automated locking systems for Reynaers Aluminium doors

FUHR automated locking systems offer a significant upgrade in terms of convenience, security, and sustainability to help make daily life easier and more comfortable.

The FUHR solutions can be easily integrated into our Reynaers Aluminium door systems. Choose between the autotronic - a partially mechanical lock with a burglarproof RC2 qualification - and multitronic system - a fully electrical, seven-point lock with an RC3 qualification - to fulfill all your safety needs.

FUHR multitronic

Automated locking systems



The FUHR multitronic multipoint locking system locks doors automatically with a motor-driven mechanism. The lock engages automatically and securely once the door has been closed and can be unlocked through a variety of access control systems.

The advantages at a glance

- Reliable twin motor: strong and fast locking and unlocking thanks to two parallel high-performance motor drive mechanisms.
- Energy savings: doors always close swiftly and tightly, keeping warmth in (or out) when you need it most. Your energy bill will thank you!
- Secure locking of main entrance doors, apartment doors, and back doors.
- Suitable for burglary-resistant doors in accordance with EN 1627 RC2 and RC3.
- Compatible with a wide variety of access control systems.
- Plug-and-play solution: complete kit with pre-assembled connectors seamlessly integrated into the door.
- Unique lock technology: integrated panic functionality and premium quality steel deadbolt and latch.

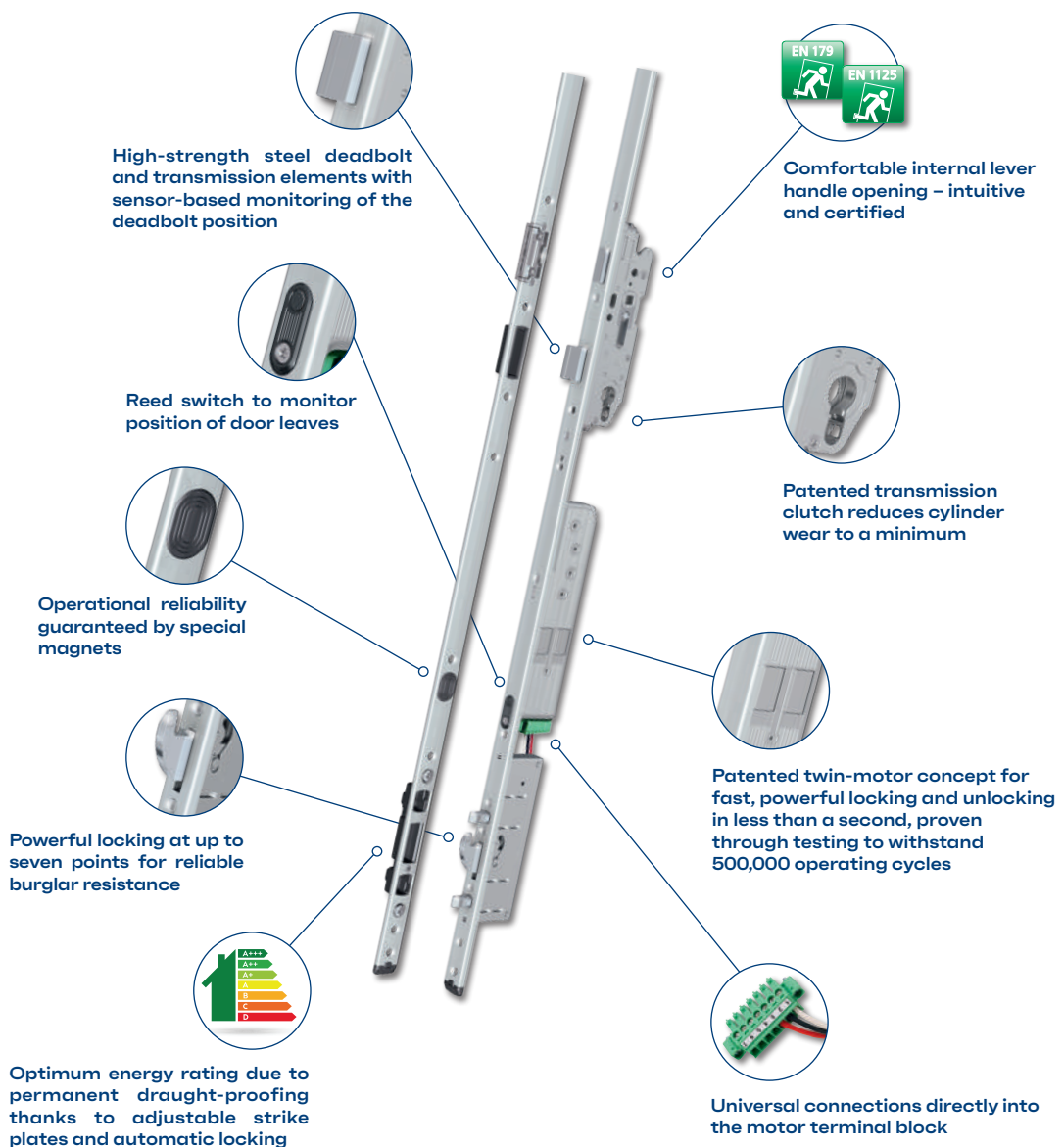

FUHR multitronic

Automated locking systems

Sustainable and secure solution

Multipoint locking ensures optimal thermal insulation to keep heated or cooled air inside any building. This way, smart locking systems help you conserve energy, save on costs and create a comfortable home or working environment.

The fully motorised multipoint locking system with built-in panic function (according to EN 179/EN 1125) is one of the most modern security systems of its kind. The ideal combination of worry-free access and excellent door security.

Well-equipped to fend off uninvited guests

Front and side doors offer a point of entry not just for your family and friends, but for unwanted guests too. Burglars are very much aware that many entrance doors are insufficiently locked - or not at all - during the day, giving them ample opportunity to take advantage. Luckily, FUHR's multitronic system locks doors automatically for maximum security.

- Panic function according to EN 179/EN 1125 as standard
- Durable and high-quality components
- Reliable seven-point lock for top-notch security up to RC3
- Comfortable motorised locking and unlocking
- Special day latch function and permanently-open function
- Plug-and-play installation



FUHR autotronic

Automated locking systems



Close the door and two latching hook bolts simultaneously and automatically swing into action and lock into place. The locked door can be opened at the push of a button.

The advantages at a glance

- Convenient and powerful motorised opening via access control systems
- Fast motorised unlocking within half a second
- Innovative bolt combination for reliable locking process and increased door security
- Optimal security: the door locks automatically and reliably at several points thanks to the new DuoSecure technology
- The latching and hook bolts automatically extend to 20 mm and are secured against being pushed back
- High-quality materials ensure a long product life
- The multipoint locking system prevents the door from warping to ensure consistent seal tightness
- The modular system makes it suitable for a wide range of Reynaers Aluminium doors



Intelligent locking options

In certain situations, you may need to deactivate your locking system temporarily. Two optional functionalities are available to do so. When the **day latch function** is engaged, the door will only be secured by the latch. This daytime solution is perfectly suited for frequently used doors in commercial or apartment buildings where controlled access is required. The system can be activated via a timer or a switch.

When the **permanent-open function** is activated, both the latch and deadbolt are permanently retracted. Unimpeded access in both directions is possible without access control. This solution is often used in shops and other buildings frequently visited by the public. Residential settings where users might want to step outside briefly without locking the door heavily benefit from this type of lock as well.

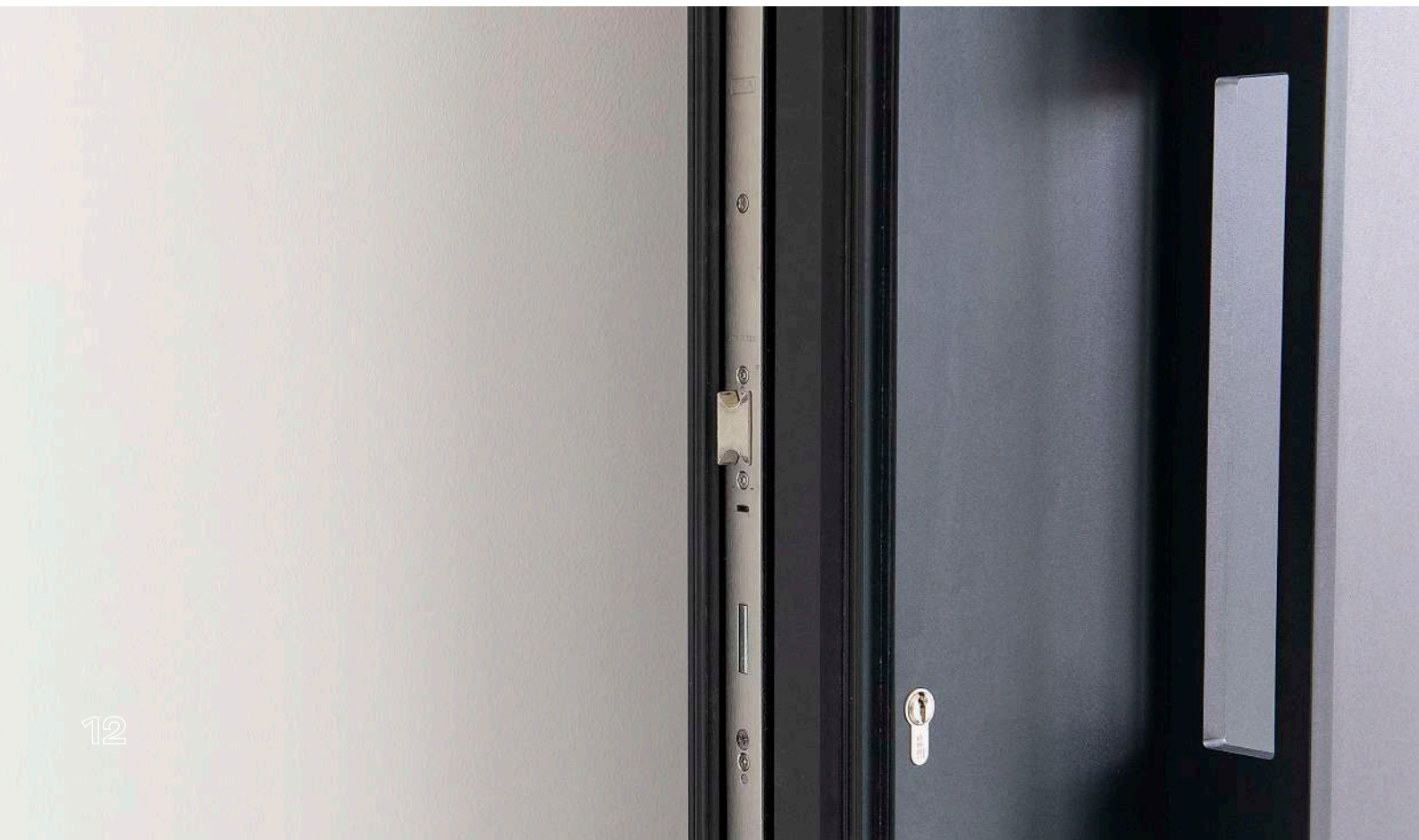

Access control for automated locks

The multitronic and autotronic motorised locking systems are based on intelligent control technology that combines convenience and security effortlessly. Pre-configured for a range of system requirements, this solution is perfectly suited for use in residential and non-residential properties where access flexibility is a must.

The multi-functional controller allows users to control a number of different functionalities:

- Access control systems such as fingerprint scanners and keypads
- Intercom
- Building management systems
- Alarm systems
- Control pulse for electrical swing door openers
- Day latch function or permanent-open function



Fingerprint scanners and keypads for smart and flexible access

Thanks to the ekey product range, fingerprint scanners have taken centre stage as the ideal access control mechanism. Keys have become redundant as you open doors with a fingertip's touch - an innovative approach that offers a number of benefits. As a result, users experience a new level of comfort and enjoy more flexibility in their everyday life.

The advantages at a glance

- No more lost or stolen keys
- Never locking yourself out again
- No transfer of access authorisation possible, like with keycards or keys
- The ekey software learns with every use, recognising the growth of children's fingers as well as changed user habits and minor injuries
- Receive a message when the door is opened or allow access remotely
- Customisable visitor access
- User-friendly app administration for fingerprint scanners



dLine fingerprint scanner

Access control

With the ekey dLine fingerprint scanner, you offer your doors a smart upgrade which includes new functions, intuitive touch operation, and easy administration via the ekey bionyx app. The dLine area sensor technology is very intuitive and can be mastered by users of all ages or levels of expertise.

While conventional keys, smartphones, codes or cards can be misplaced, forgotten, or even lost, your finger is always on hand. But the dLine fingerprint scanner goes even further and offers a new feeling of comfort with smart features that make everyday life easier. If you choose the ekey dLine, you choose an intelligent access control system that meets the wishes of tomorrow today.



With an elegant stainless steel or black finish, the dLine fingerprint scanner is specifically designed for seamless integration in Reynaers Aluminium doors and door pulls, frames, or even your walls. Other daily benefits include:

- Keyless access
- Convenient remote opening
- Automatic push notifications
- User-friendly functionality and design
- Expandable at any time
- Smart home connectivity
- Maximum security 24/7
- Regular updates in app to offer the latest solutions

dLine in doorpull



Keypads

Access control

The ekey keypad is equipped with intelligent software that transmits information to the control panel using encrypted communication. Ekey has placed special emphasis on design and the use of high-quality materials, for an intelligent solution that looks good and can be easily mounted right next to your door.

The ekey keypad code pad offers up to 99 different four- to eight-digit programmable number sequences - plenty enough for each user in the building to get their own access code. Because of the integrated backlighting, users can quickly and easily insert their own personal code - even in the dark. And if a user or guest is no longer permitted access to the building, their code can be deleted in seconds.



Keypad black



Keypad white



Keypad Lite

For secondary entrance applications and projects with a higher number of users, we provide an economic keypad. This single-entry standalone keypad with easy plug-and-play setup comes with an anti-tamper alarm and is available in a black and stainless steel colour.

The Keypad Lite can contain up to 10 temporary codes with limited use for visitors.

Technical overview

	dLine	Keypad
False Acceptance Rate	1:10,000,000/FRR 1: 100	NA
Dimensions (WxHxD)	22.3 x 46.8 x 16 mm	51.7 x 97.1 x 21.4 mm
Power consumption	approx. 1 W	approx. 1 W
Supply voltage	12-24 VDC	8-24 VDC
IP code	IP56	IP54
Recommended mounting height	155 cm	NA
Memory	Up to 100 different users can be stored, data is retained in the event of power failure	Up to 99 different four- to eight-digit codes can be programmed simultaneously
Temperature range	-25 °C to 70 °C	-25 °C to 70 °C
Activated by	Fingerprint, app	Code
Colours	Black or stainless steel	Black or white

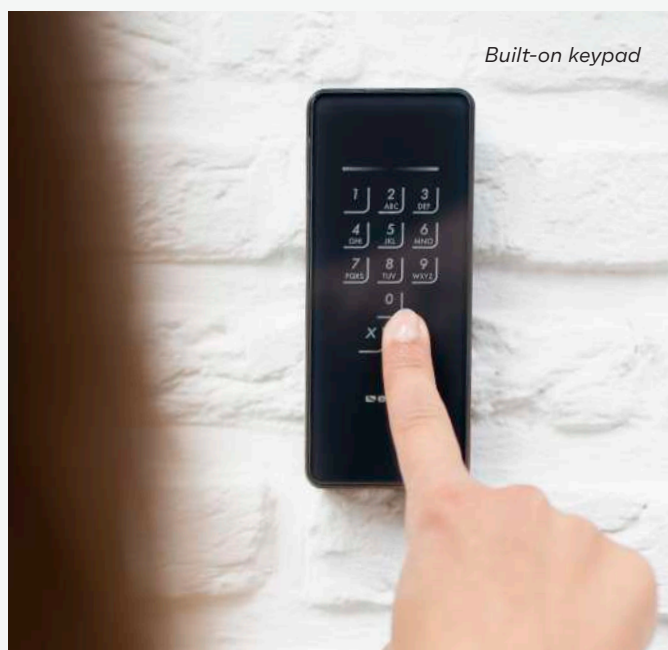

Automated sliding doors

A woman with long brown hair, wearing a dark blue and green striped dress, stands in a modern interior. She is holding a wooden tray with a selection of fruits and cheeses in her left hand and a glass of wine with a straw in her right hand. She is looking towards a large, dark-framed sliding glass door on the right side of the frame. The background shows a blurred kitchen area with a white countertop and dark cabinets.

Opening sliding doors at the touch of a button

Being able to automatically open or close a sliding door boosts the accessibility of any residential or commercial building. At Reynaers Aluminium, we aim to make that process as easy as possible. Next to offering high-quality materials and contemporary design, we go the extra mile by providing a number of automated solutions that allow you to open and close sliding doors at the push of a button. Thanks to these smart and seamlessly integrated solutions, operating sliding doors has never been easier.



Concealed Motorised Solutions

All automated access solutions for sliding doors include concealed motors that can be seamlessly integrated into our windows and doors to safeguard the design of the building. That way, you can both enjoy easy access and the unique minimalist design of our HiFinity, MasterPatio and ConceptPatio 155 (-LS) sliding doors.

HiFinity

Motorised sliding system

The ultra-slim design of HiFinity sliding doors creates large transparent surfaces with a sleek and elegant design. Looking for the perfect finishing touch? An integrated concealed motor allows users to open the sashes at the push of a button, or via a connected home or building automation system. A separate manual handle is no longer required: the high-performance motor guarantees optimum convenience during use and offers a safe and reliable access solution.

With HiFinity's electronic lock, you will never have to worry about uninvited guests again. The door locks and unlocks thanks to a robust bolt operated by a button or via your smart home or building system. In addition, the integrated alarm feedback helps ensure ultimate peace of mind.

The HiFinity motor is available in a 50 W version that can move sashes of up to 425 kg, and a 70 W version that supports weights of up to 750 kg.



MasterPatio

Motorised lift-slide system

Crafted by Masters, the MasterPatio lift-slide system takes your home to the next level. Beauty and performance come together as this spectacular floor-to-ceiling solution offers Passive House insulation levels to keep you warm and safe all year long. MasterPatio is the sliding system of choice for all our partners and customers. Its recycled components and excellent energy performance make this aluminium solution an ideal sustainable upgrade for any building project, as proven by its Minergie Module certificate.



Explore endless architectural options as the MasterPatio is fully compatible with our MasterLine 8 windows and doors range. Reaching heights of up to 3.6 m, this sliding system neatly integrates into building façades to provide you with lots of light and amazing panoramic views.

A motorised version is newly available for MasterPatio's monorail lift-slide variant, with an additional built-in 50 W motor to lift vents of up to 400 kg. When the vent is closed, it automatically locks itself in a second. User-friendly design has never looked better.

ConceptPatio 155

Motorised lift-slide system

ConceptPatio 155 (-LS) is a versatile insulated lift-slide system designed to deliver maximum ease of use. For added convenience, the doors can be automated with a concealed motor solution that allows users to open the sashes at a push of a button, or via their smart home or smart building app.

The lift-slide version of the ConceptPatio 155 has an additional built-in 50 W motor that can lift vents of up to 400 kg effortlessly. When the sash is closed, it automatically locks itself, giving airtight security to all.



The HiFinity sliding system, MasterPatio, and ConceptPatio 155 (-LS) lift-slide system

are equipped with pressure-sensitive emergency detection to keep you, your children and your pets safe at all times. When feeling even the slightest resistance, the doors stop immediately and the motor is automatically reversed to free any obstacles. Moreover, a built-in battery pack makes sure sashes can always be opened, even in case of power failure.

Access control for sliding doors

Element controller

With the element controller, you can now easily integrate smart access control for sliding doors into your home and building automation systems. Open and close multiple motorised doors with ease, whenever you want to. You can even set pre-defined sash states, close specific sashes, open all sashes at once, and much more. The user-friendly system is designed to make the setup and control of multiple sliders very intuitive. That way, you can operate the motorised vents according to each resident's individual needs. In addition, an anti-collision safety feature prevents you, your children or your pets of getting trapped between the moving vent. Nothing is left to chance.

- Safety first: real-time position-based anti-collision control
- Intuitive operation of multiple sliding sashes
- Easy handling of multiple vents via single control point for multiple motorised sashes
- Unified control thanks to full integration in home automation systems

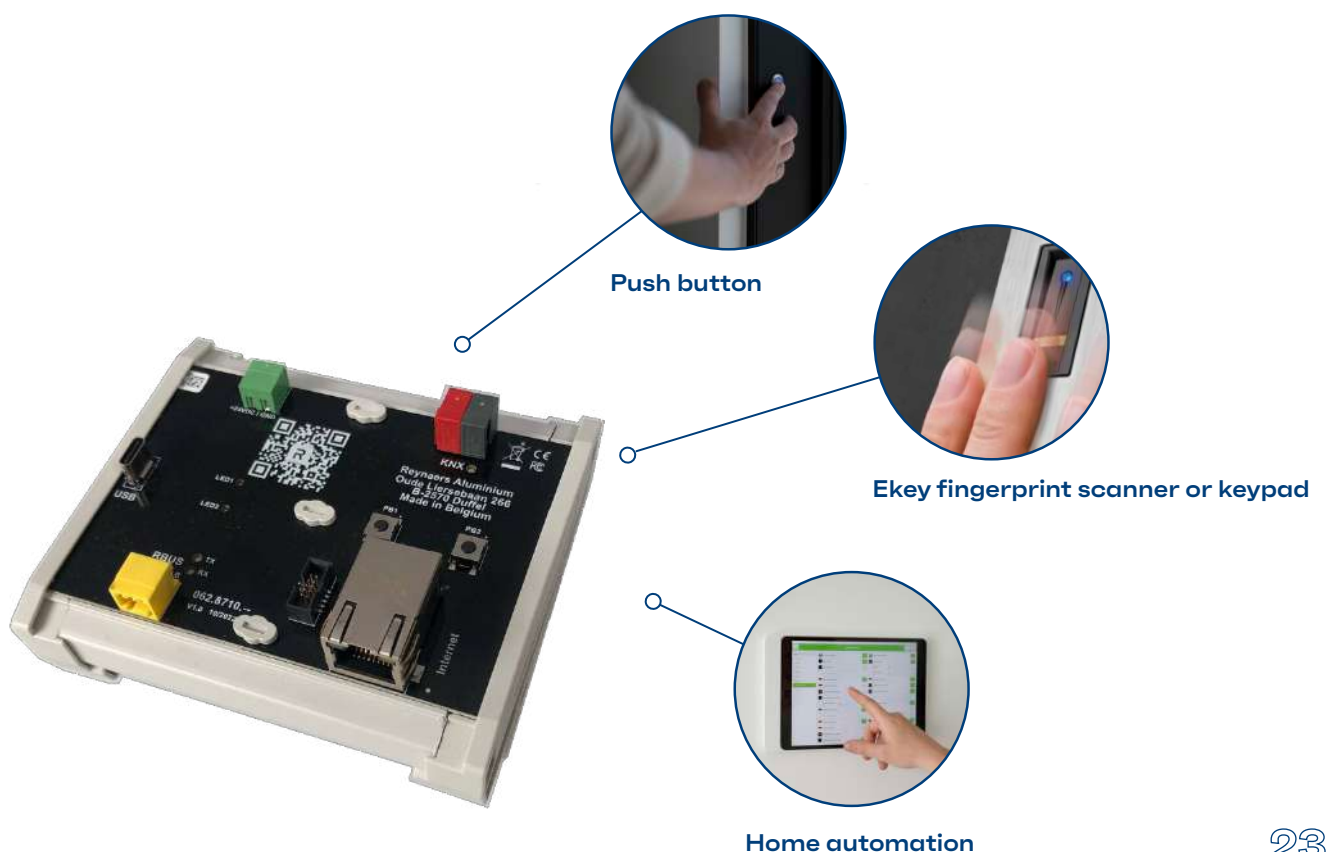

Natural ventilation

Natural ventilation and creating a healthy indoor environment has never been this topical. Simply opening a window helps to bring in some fresh air and prevents indoor overheating by passive cooling. At Reynaers Aluminium, we believe that motorised windows can improve indoor air quality and your comfort in an economical and impactful way.

To improve your work and living conditions, we offer premium user-friendly solutions that work as either standalone units, or link to your smart home network or HVAC (heating, ventilation, and cooling) systems. And just like any other of our Smart Building solutions, Reynaers Aluminium motorised windows for natural ventilation are always subtly integrated, fully connected and safe to use.

E-Invisitop

E-Invisitop is a comfort motorisation solution for windows that are not that easy to reach. A single motor (060.6770.-), integrated and concealed into the vent, helps you to tilt and (un)lock the window with utmost ease.

- For concealed, bottom-hung windows
- For inward opening windows with 175 mm and 200-600 m³/h air changes
- Ideal for comfort opening at residential buildings





Ventilation vent

Create an optimal flow of fresh air and a healthy indoor climate with our motorised ventilation vents. The concealed vents' narrow design helps to offer a breath of fresh air while ensuring full safety at all times. This aesthetic solution is both easy to install and easy to integrate, as you can adjust the end pieces for optimal fit and paint them to match the colour of your profiles.

Speaking of seamless integration: our ventilation vents are fully compatible with MasterLine 8 windows and doors, and MasterPatio sliding systems. As a result, you can create incredible floor-to-ceiling façades that feature nothing but Reynaers Aluminium solutions.

When it comes to motorised solutions that anyone can operate, safety is key. Thanks to our ventilation vents' finger pinch protection feature, even children can operate the system in full safety. The vents' fall-through front grid protection ensure no-one falls out of the window, even on higher building levels. Furthermore, this burglarproof solution protects against rain and mosquitoes to make your life that more enjoyable.

- Concealed motorised ventilation vent, operated from the inside
- For inward opening, 90° side-hung windows with 250-1500 m³/h air changes
- Burglarproof solution with fall-through front grid protection
- Ideal for residential, natural ventilation

Magnetic contacts

Magnetic contacts are your certified solution for reliable alarm feedback. Activate your smart home, security, and HVAC (heating, ventilation, air-conditioning) systems thanks to this integrated access control feature.

How does it work? An interruption of the reed-contact will trigger an alarm to go off. Based on the status of your vents (open or closed), any connected system will activate automatically to help you reduce heating or cooling loss in an instant. Thanks to magnetic contacts by Reynaers Aluminium, saving energy has become that much easier.



Our magnetic contacts comply with various international standards and certificates:

- EN 50131-2-6 Grade 2, Class IA or IIIA
- INCERT B-582-0013
- VdS G116504 or G199523, Class B
- SBSC 9-216, Class 1/2, F&P, FGS

This innovative access solution is available for Reynaers Aluminium doors, sliding doors, and windows. Reach out to your local sales contact person for more information, or visit our website: www.reynaers.com







**Reynaers
Aluminium**

Oude Liersebaan 266
B-2570 Duffel

T +32 (0)15 30 88 10
info@reynaers.com

www.reynaers.com