

distinctive
steel
window
systems

OTTOSTUMM | **mogs**



Swiss technology, italian design

Minimalistic windows and doors, large sliding and folding openings, hot-rolled steel windows with evocative appeal as well as customized solutions for curtain walls: Ottostumm | Mogs systems in steel and architectural bronze are characterised by a valuable and contemporary design, permeated with the finest Italian style and manufactured with Swiss state-of-the-art technology.

A profile design harmonized down to the smallest detail allows the production of high-quality windows and doors in combination with highly efficient insulating glass units. The very high quality of steel and bronze alloys and the variety of the Ottostumm | Mogs system range mean that there are virtually no limits to design creativity, both in modern architecture and in the restoration of historic and listed buildings.

Ottostumm | Mogs combines essential functions with unique design, and sets new standards with a timeless style.

Tecnologia svizzera, design italiano

Porte e finestre, aperture scorrevoli anche di grandi dimensioni, FerroFinestra e facciate continue: i serramenti realizzati con i sistemi Ottostumm | Mogs in acciaio e Bronzo Architettonico sono caratterizzati da un design essenziale e contemporaneo, permeato del miglior gusto italiano e supportato dall'alta tecnologia svizzera.

Lo studio attento del design dei profili - prodotti in linee ad alta precisione svizzera - garantisce la realizzazione di serramenti perfetti, e permette l'inserimento di lastre vetrate di ultima generazione. L'alta qualità delle leghe di acciaio e di bronzo, lo spessore adeguato della lamiera, la versatilità e l'ampiezza di gamma, fanno dei sistemi Ottostumm | Mogs la soluzione di più alto valore a qualsiasi esigenza progettuale, sia nell'architettura moderna che negli interventi di riqualificazione urbana.

Con un comune intento: raggiungere l'essenza della funzione, e tradurla in uno stile senza tempo.



FerroFinestra Stucco

profile range

-01 Hot rolled steel -12 Bright steel

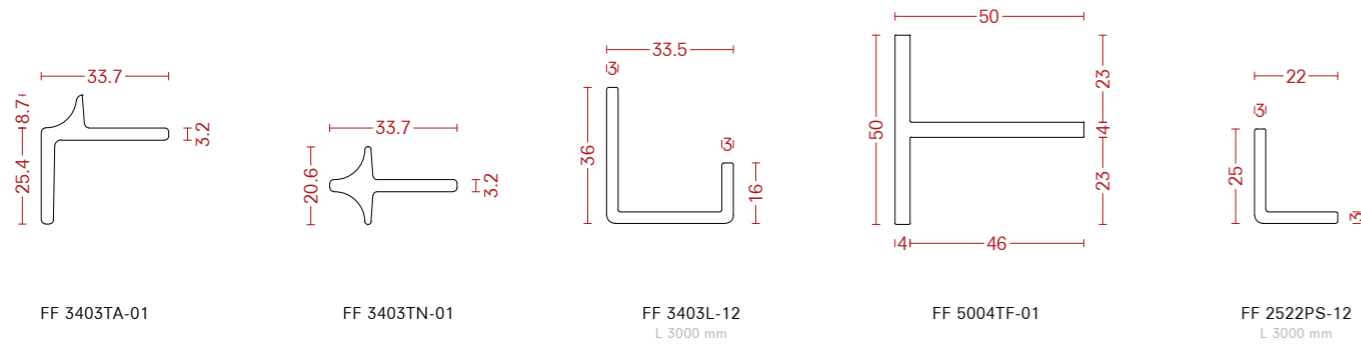

glazing beads

-01 Hot rolled steel



FV 1010R-01

gaskets

-60 Black EPDM -61 Neoprene -62 PVC

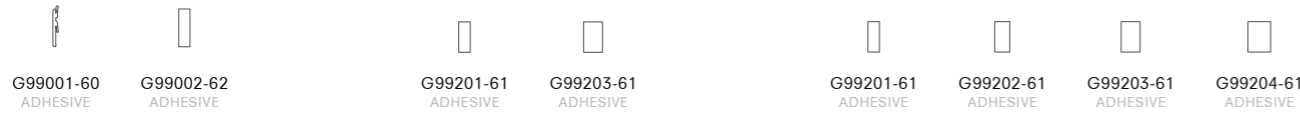

FerroFinestra W20

profile range

-01 Hot rolled steel -14 Laser welded and sand blasted steel

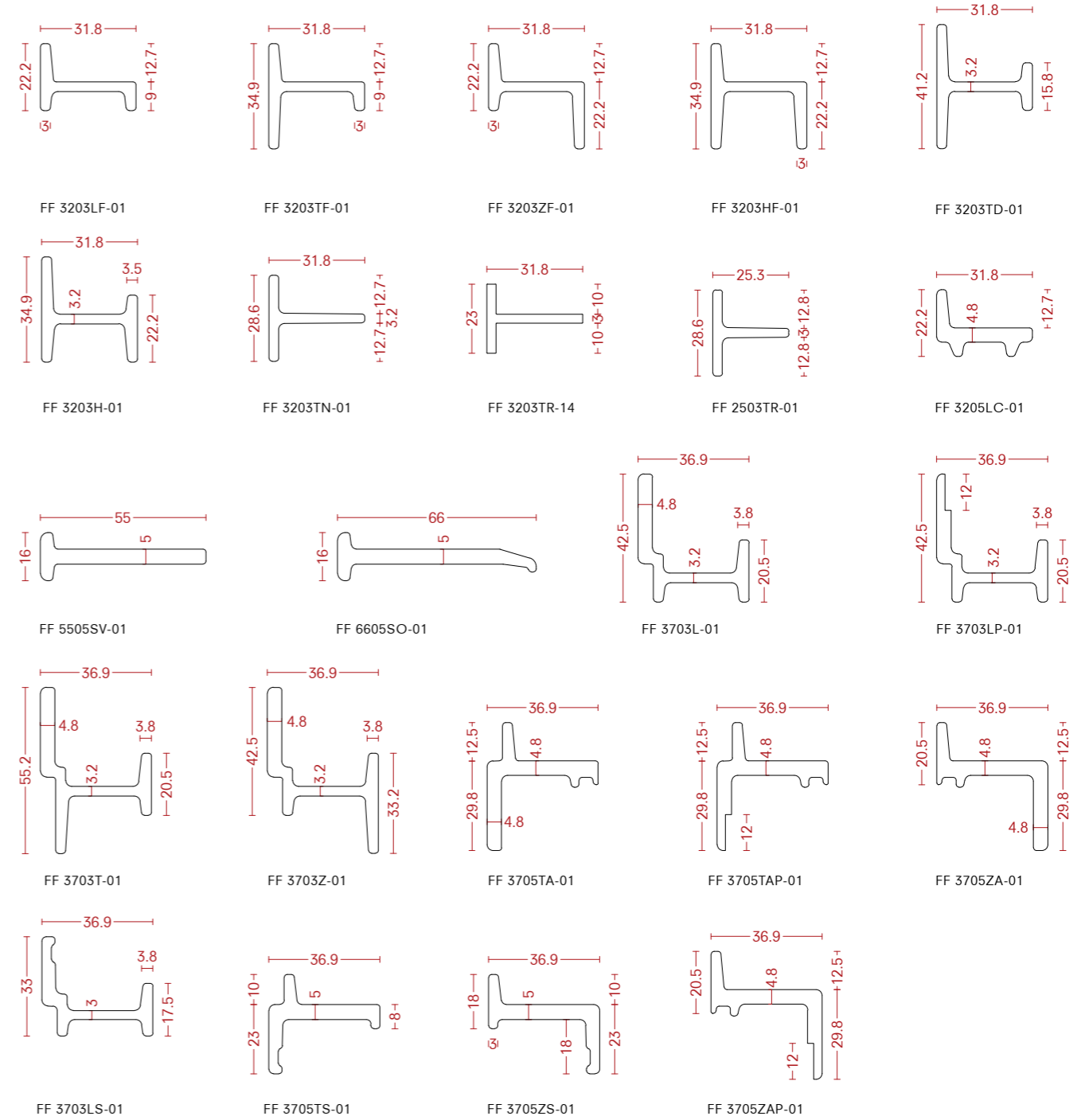

glazing beads

-00 Aluminium -01 Hot rolled steel

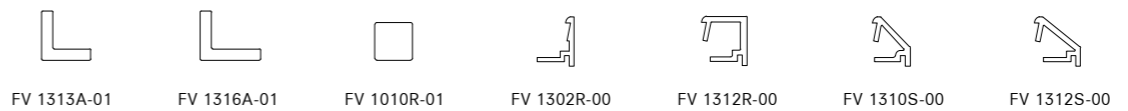

gaskets

-60 Black EPDM -61 Neoprene -62 PVC

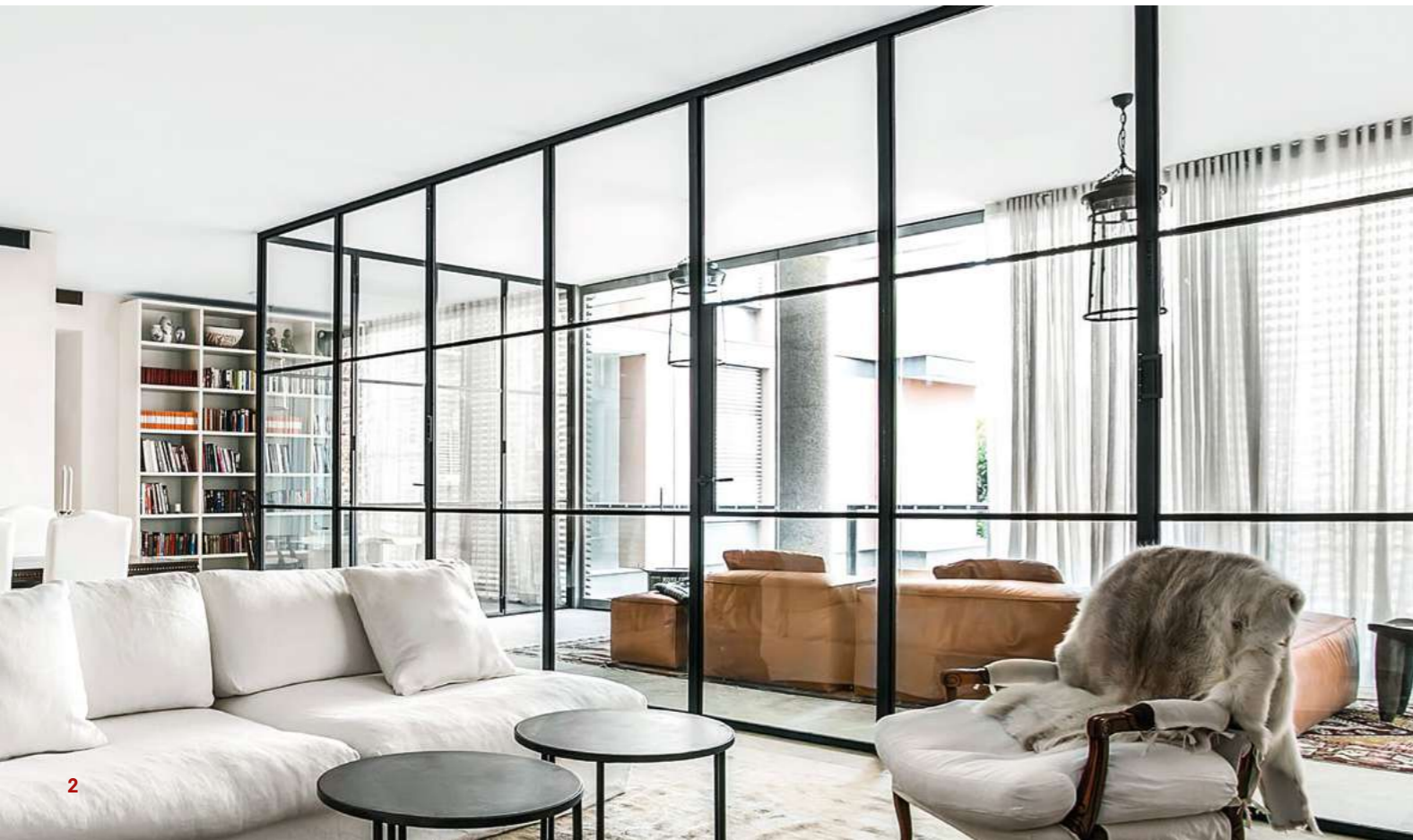
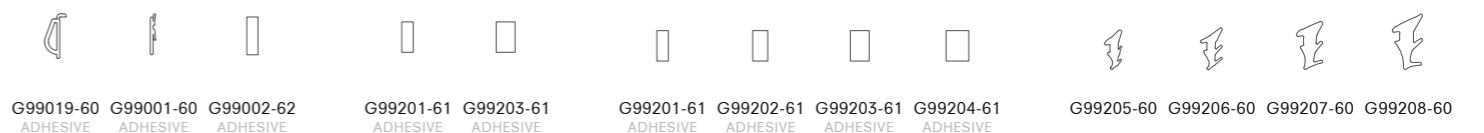

FerroFinestra W40

profile range

-01 Hot rolled steel -14 Laser welded and sand blasted steel

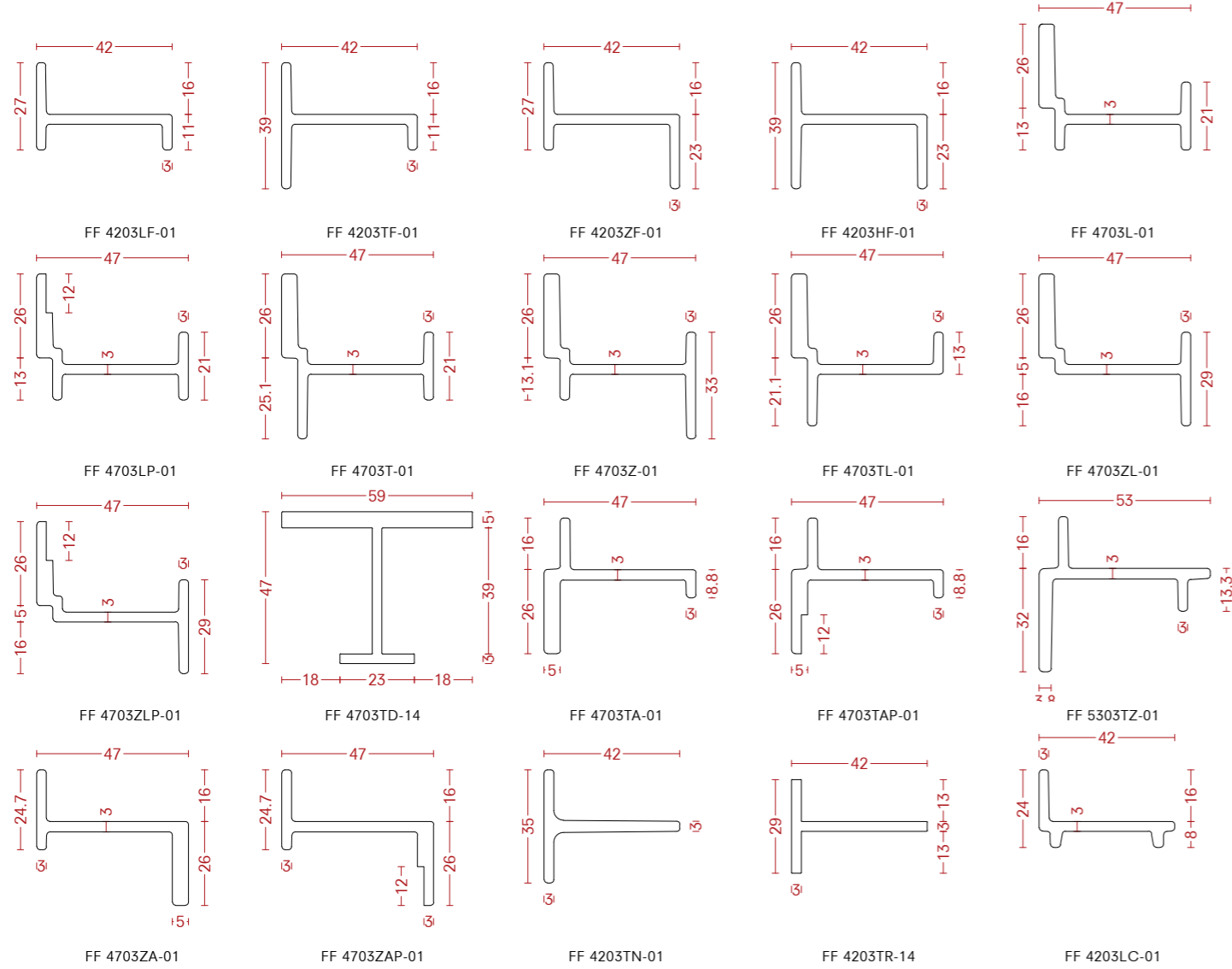

glazing beads

-00 Aluminium -01 Hot rolled steel -02 Galvanized steel

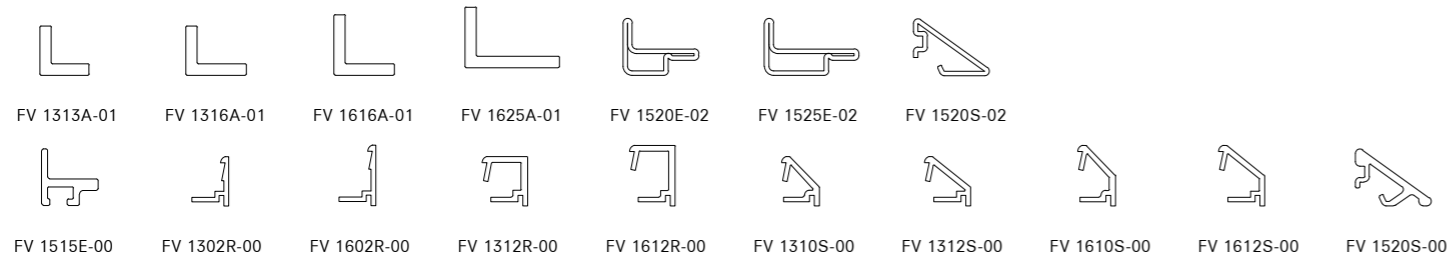

gaskets

-60 Black EPDM -61 Neoprene -62 PVC

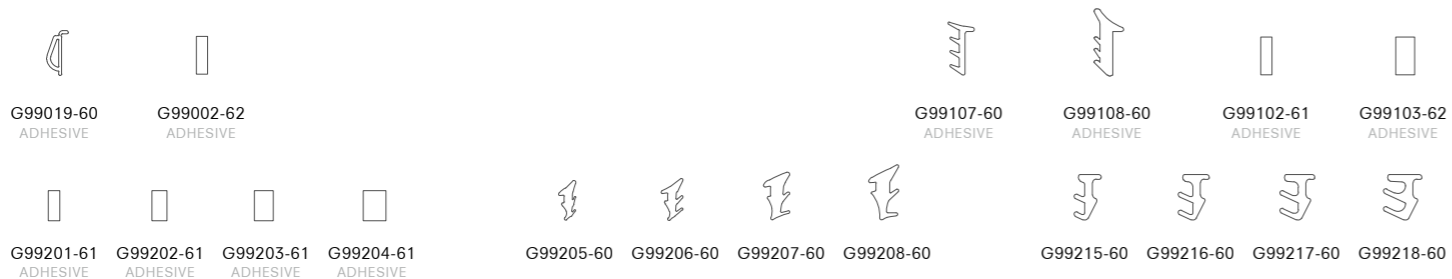

FerroFinestra W50 TB

profile range

-00 Aluminium -02 Galvanized steel

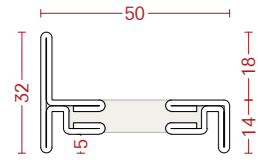

FT 5009LF-02

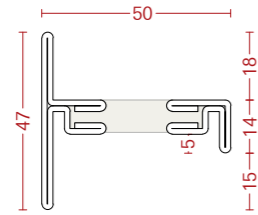

FT 5009TF-02

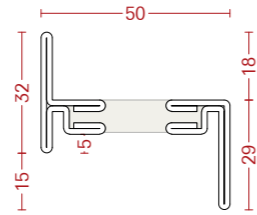

FT 5009ZF-02

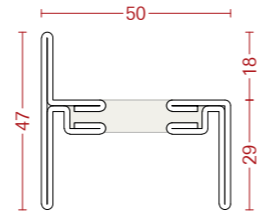

FT 5009HF-02

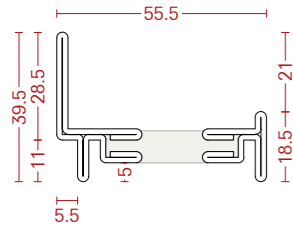

FT 5509L-02

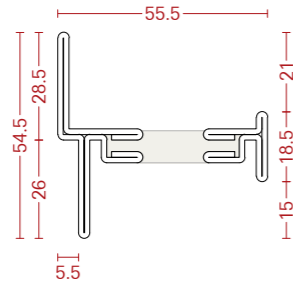

FT 5509T-02

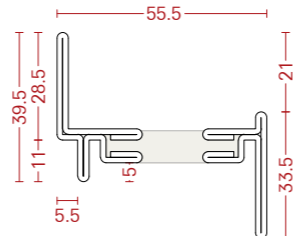

FT 5509Z-02

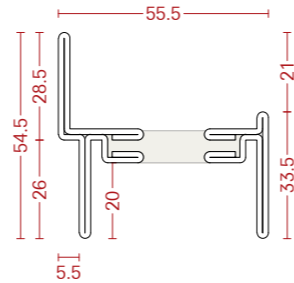

FT 5509H-02

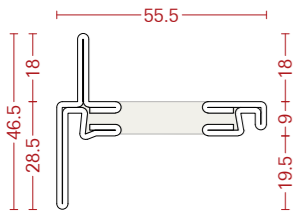

FT 5509TA-02

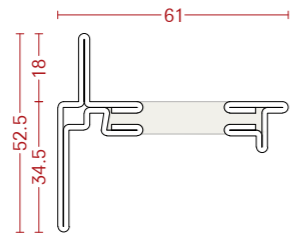

FT 6109TZ-02

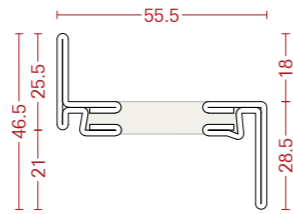

FT 5509ZA-02

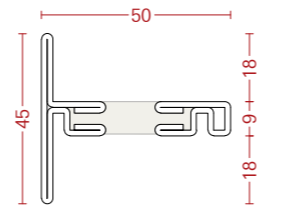

FT 5009TN-02

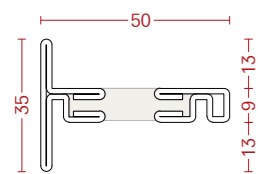

FT 5009TR-02

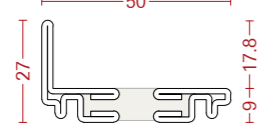

FT 5009LC-02

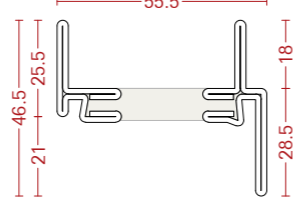

FT 5509HP-02

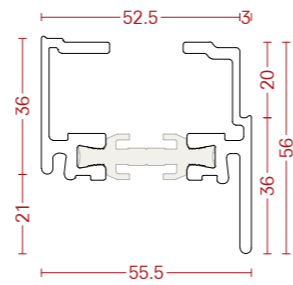

FT 5512RS-00

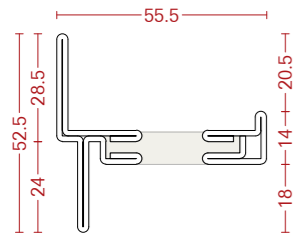

FT 5509TL-02

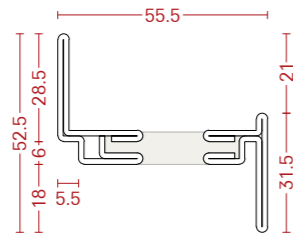

FT 5509ZL-02

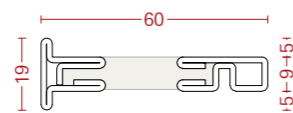

FT 6009SV-02

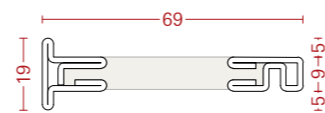

FT 6909SO-02

glazing beads

-00 Aluminium -01 Hot rolled steel -02 Galvanized steel

*on request - minimum quantity required



FV 1515A-02



FV 1815A-02

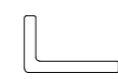

FV 1525A-01



FV 1515D-02 *



FV 1815D-02 *



FV 1803R-02



FV 1807R-02



FV 1810R-02

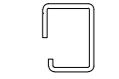

FV 1813R-02

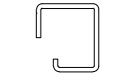

FV 1816R-02



FV 1302R-00



FV 1602R-00



FV 1312R-00



FV 1612R-00



FV 1310S-00



FV 1312S-00



FV 1610S-00



FV 1612S-00



FV 1312B-00



FV 1612B-00

gaskets

-60 Black EPDM -61 Neoprene -62 PVC -77 White EPDM



G04016-60
G04016-77



G04018-60
G04018-77



G99002-62
ADHESIVE



G99107-60
ADHESIVE



G99108-60
ADHESIVE



G99102-61
ADHESIVE



G99103-62
ADHESIVE



G99201-61
ADHESIVE



G99202-61
ADHESIVE



G99203-61
ADHESIVE



G99204-61
ADHESIVE



G99205-60



G99206-60



G99207-60



G99208-60



FerroFinestra W75 TB

profile range

-02 Galvanized steel -05 Stainless steel AISI 316L 2B -07 Cor-Ten steel -12 Bright steel

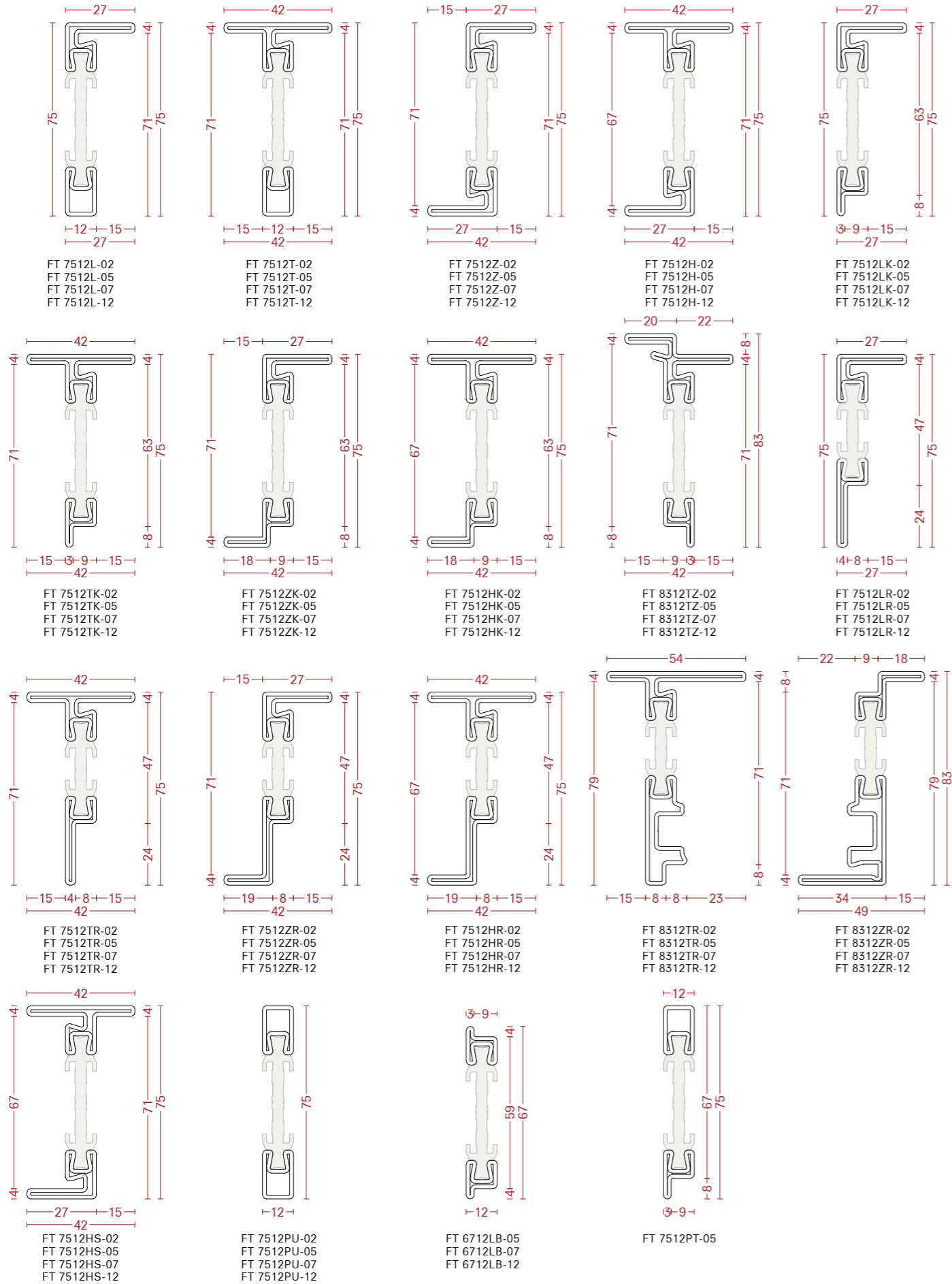

glazing beads

-00 Aluminium -01 Hot rolled steel -02 Galvanized steel -05 Stainless steel AISI 316L 2B -06 Satin stainless steel AISI 316L
-07 Cor-Ten steel -12 Bright steel

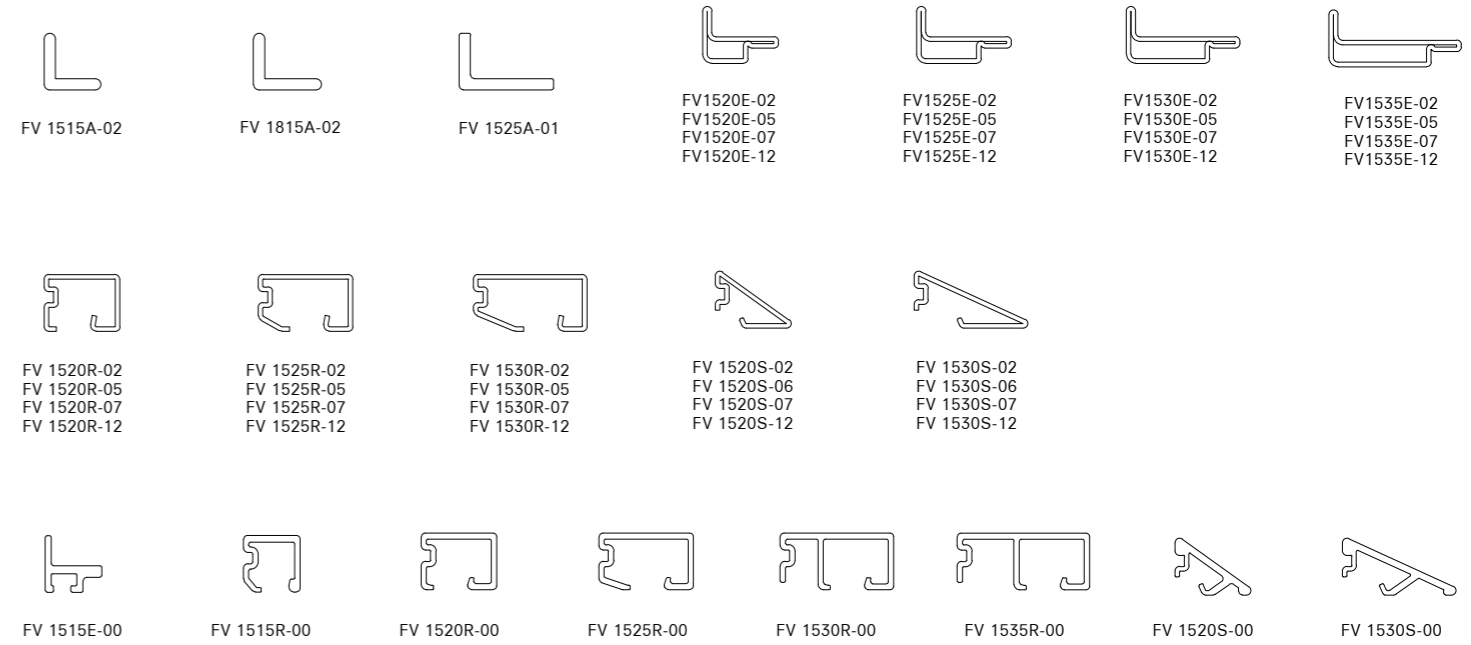

gaskets

-60 Black EPDM -61 Neoprene -62 PVC -77 White EPDM

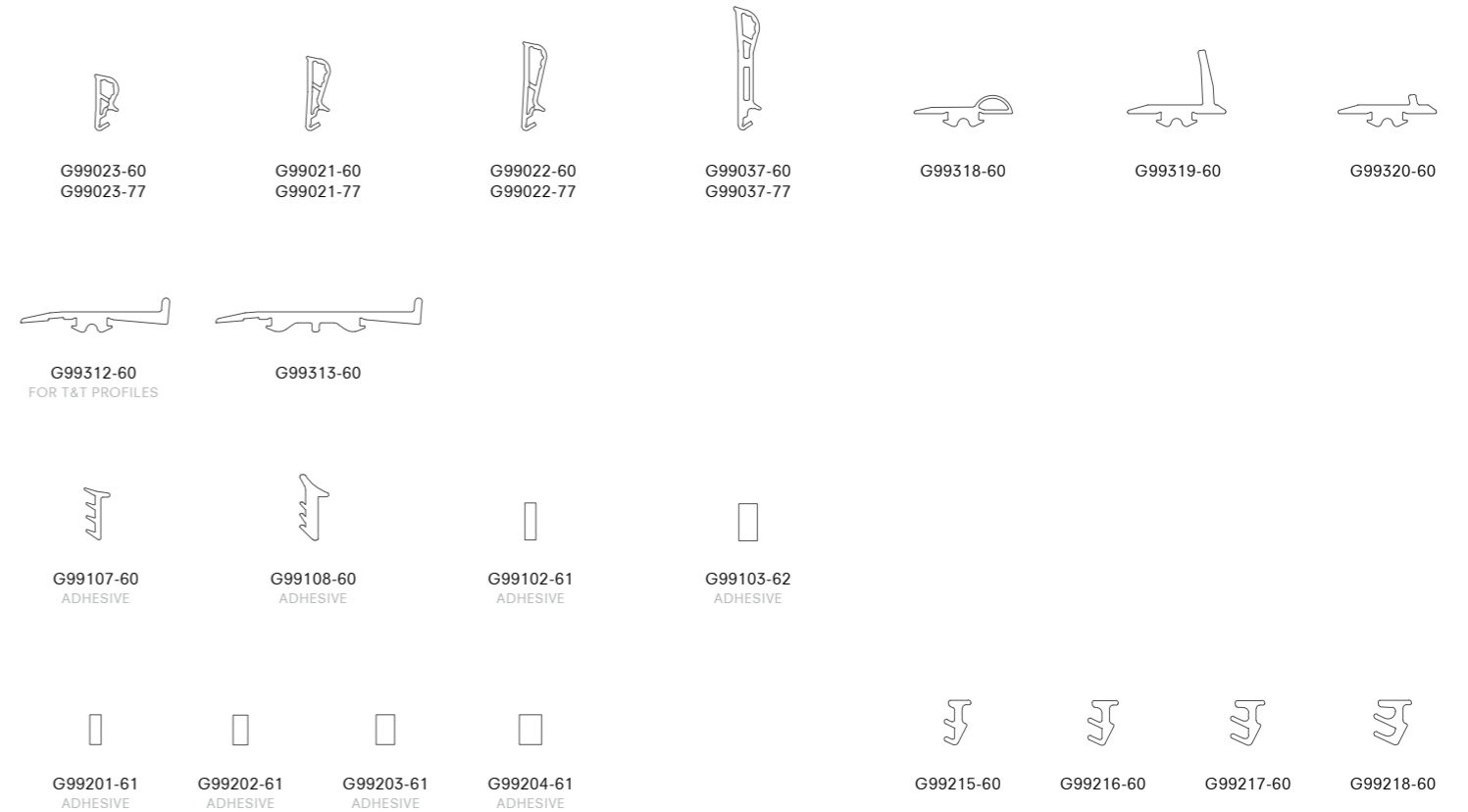



0,00 - 24,00
vietato parcheggiare
0,00 - 24,00

FerroFinestra D75 TB

profile range

-02 Galvanized steel -05 Stainless steel AISI 316L 2B -07 Cor-Ten steel -12 Bright steel

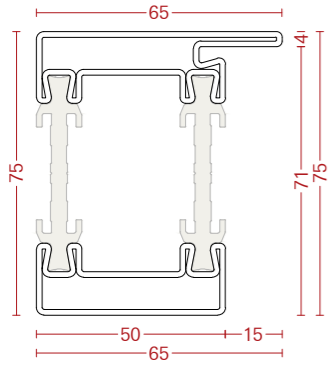

FT 7550LF-02
FT 7550LF-05
FT 7550LF-07
FT 7550LF-12

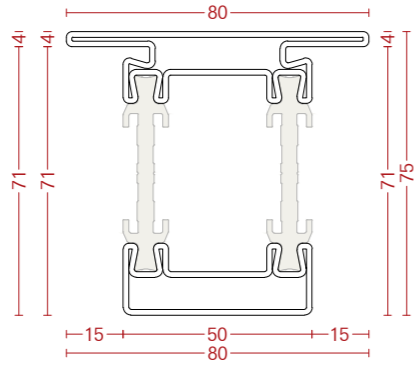

FT 7550TF-02
FT 7550TF-05
FT 7550TF-07
FT 7550TF-12

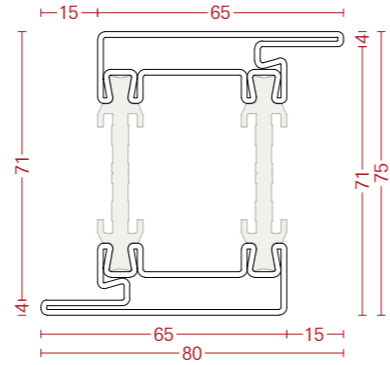

FT 7550ZF-02
FT 7550ZF-05
FT 7550ZF-07
FT 7550ZF-12

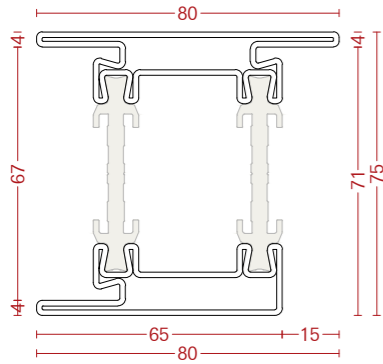

FT 7550HF-02
FT 7550HF-05
FT 7550HF-07
FT 7550HF-12

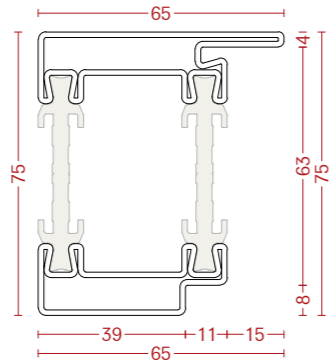

FT 7550L-02
FT 7550L-05
FT 7550L-07
FT 7550L-12

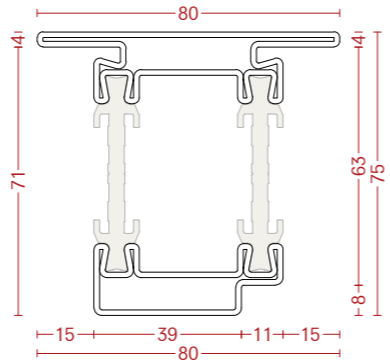

FT 7550T-02
FT 7550T-05
FT 7550T-07
FT 7550T-12

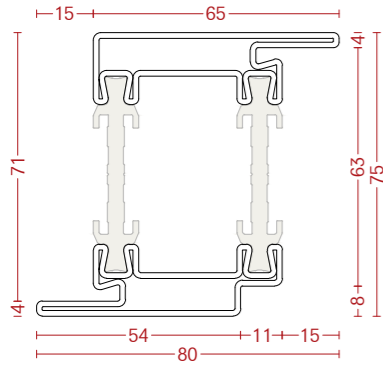

FT 7550Z-02
FT 7550Z-05
FT 7550Z-07
FT 7550Z-12

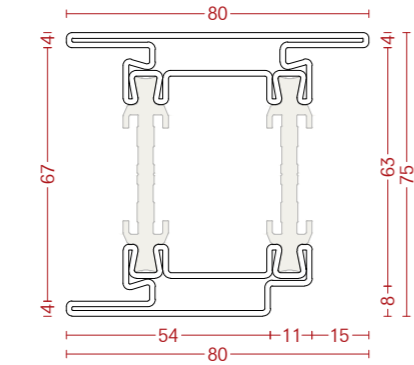

FT 7550H-02
FT 7550H-05
FT 7550H-07
FT 7550H-12

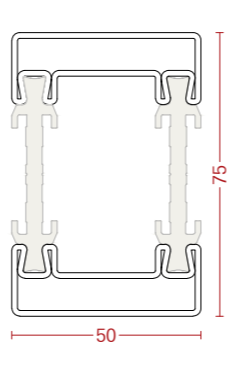

FT 7550PU-02
FT 7550PU-05
FT 7550PU-07
FT 7550PU-12

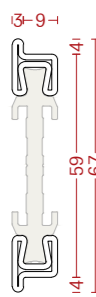

FT 6712LB-05
FT 6712LB-07
FT 6712LB-12

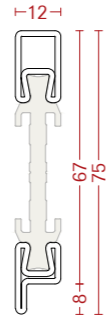

FT 7512PT-05

FOR GLAZING BEADS AND GASKETS, PLEASE SEE FERROFINESTRA W75 TB.

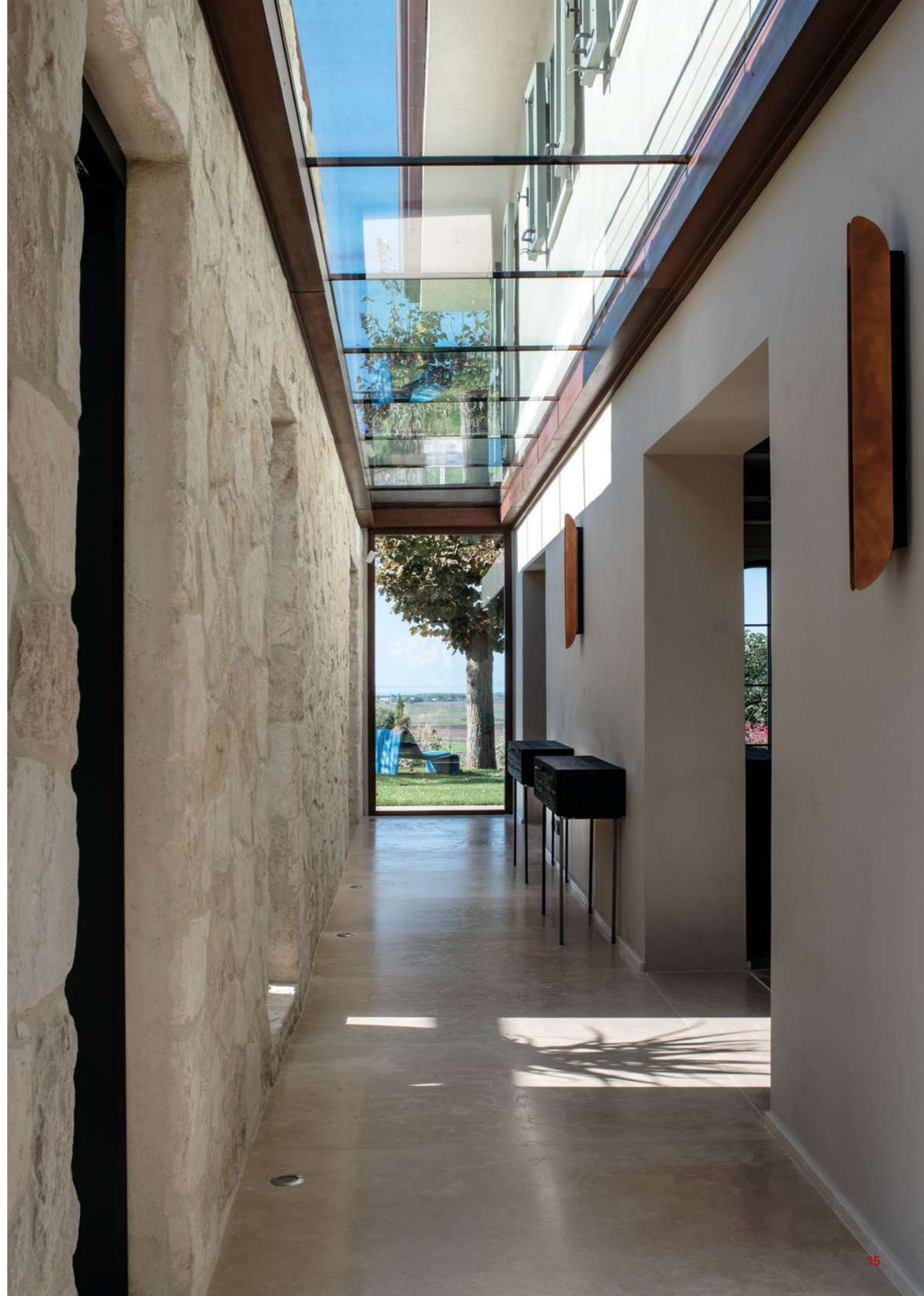

FerroFinestra WLS75 TB - Lift&Slide

profile range

-02 Galvanized steel -05 Stainless steel AISI 316L 2B -06 Satin stainless steel AISI 316L -07 Cor-Ten steel -12 Bright steel
 -53 Aluminium electrocolor black -62 PVC -66 GRP

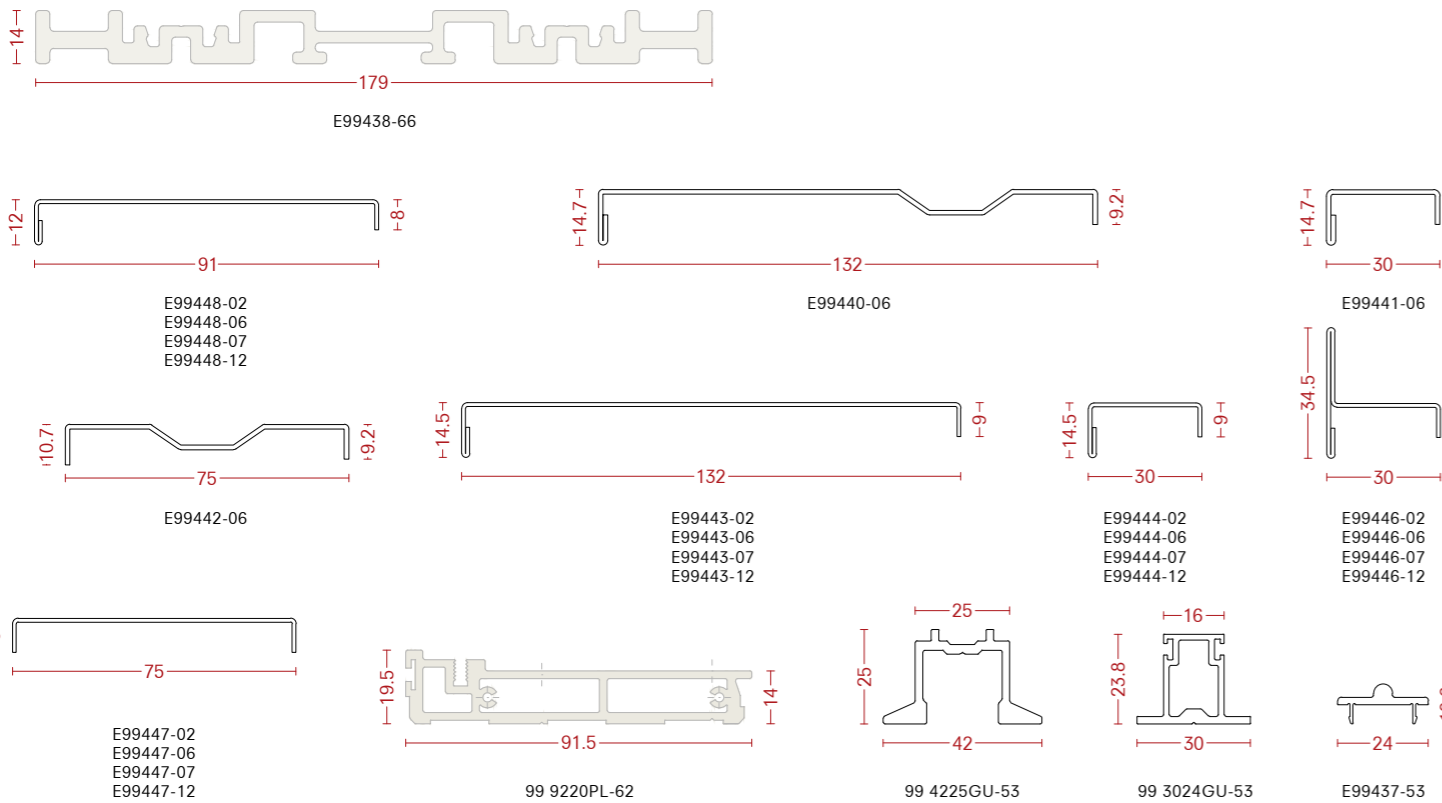
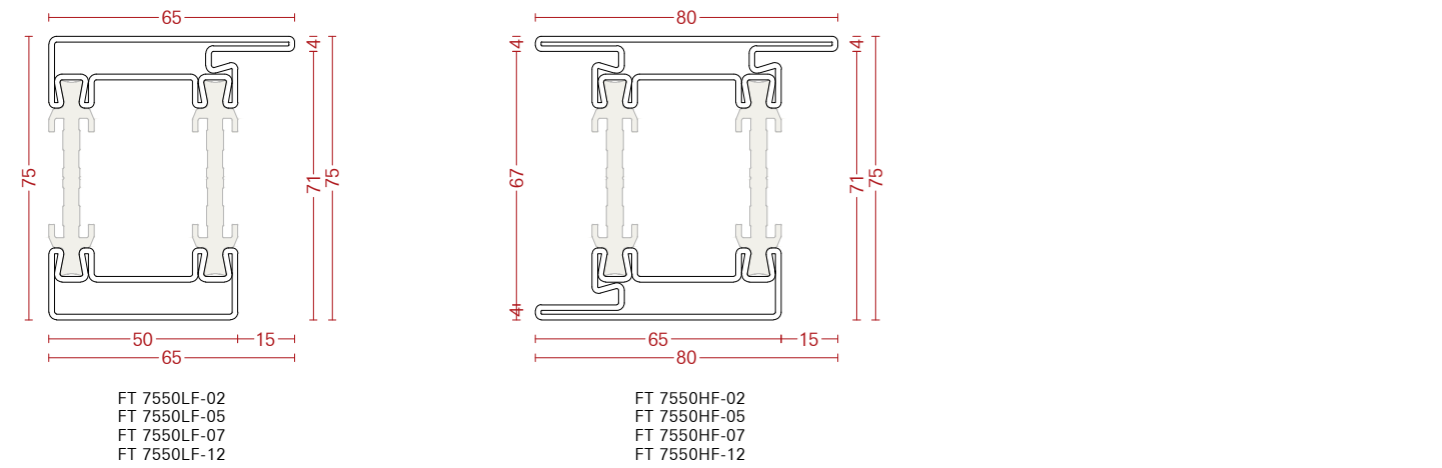
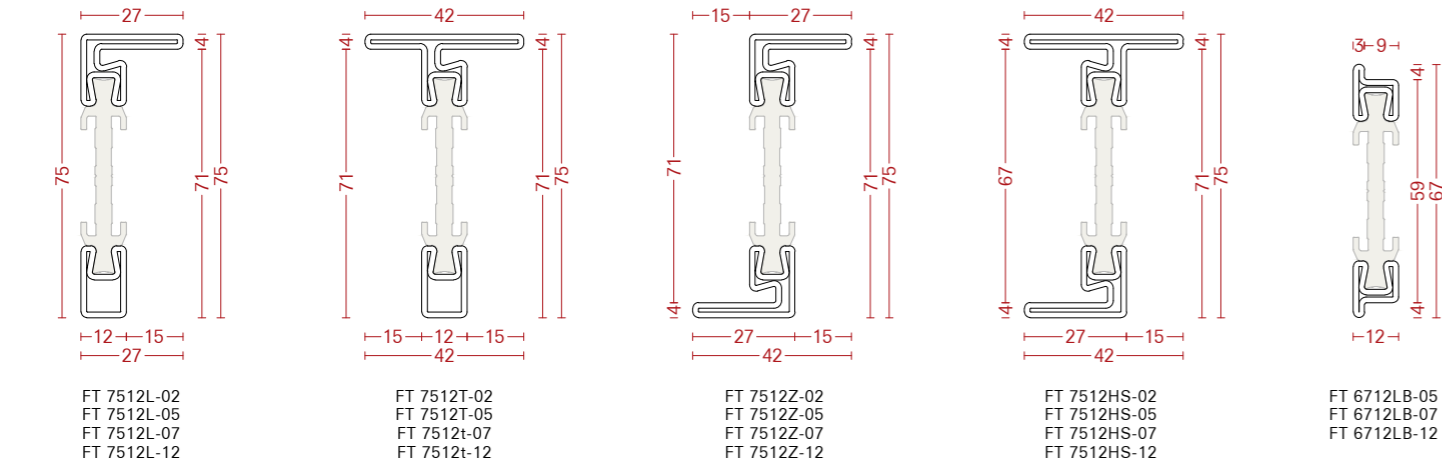

glazing beads

-00 Aluminium -01 Hot rolled steel -02 Galvanized steel -03 Stainless steel AISI 304 2B -05 Stainless steel AISI 316L 2B
 -06 Satin stainless steel AISI 316L -07 Cor-Ten steel -12 Bright steel

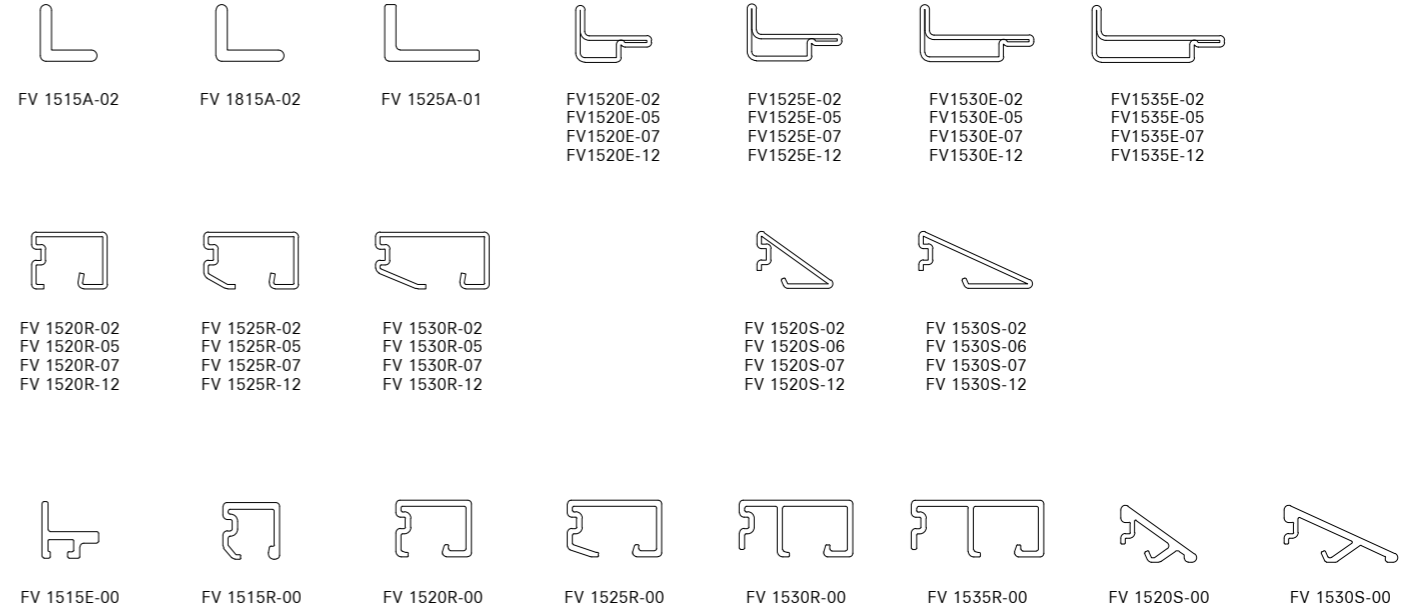

gaskets

-60 Black EPDM -61 Neoprene -62 PVC -64 Silicone -77 White EPDM

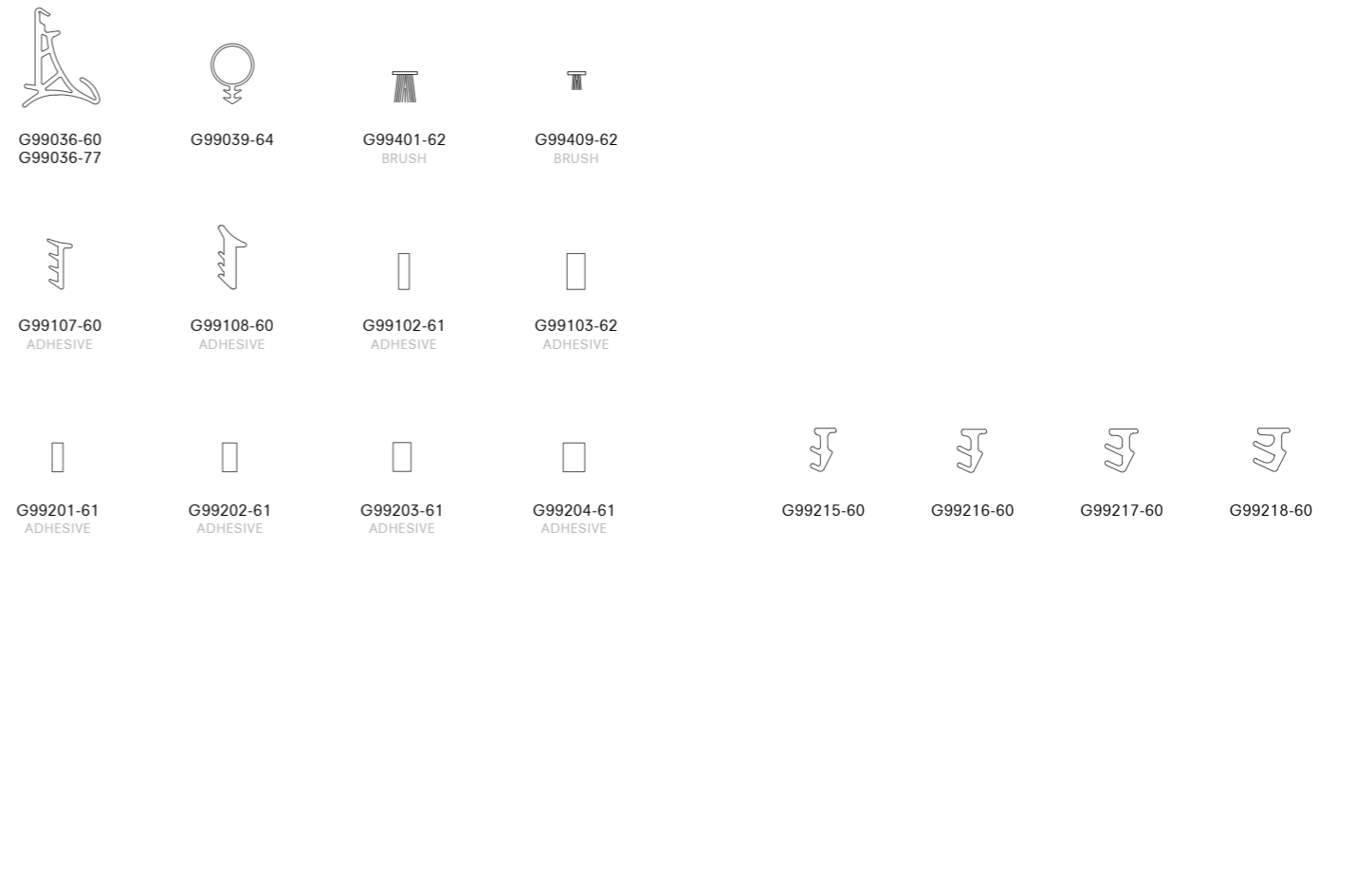

BronzoFinestra B40

profile range

-08 Architectural bronze

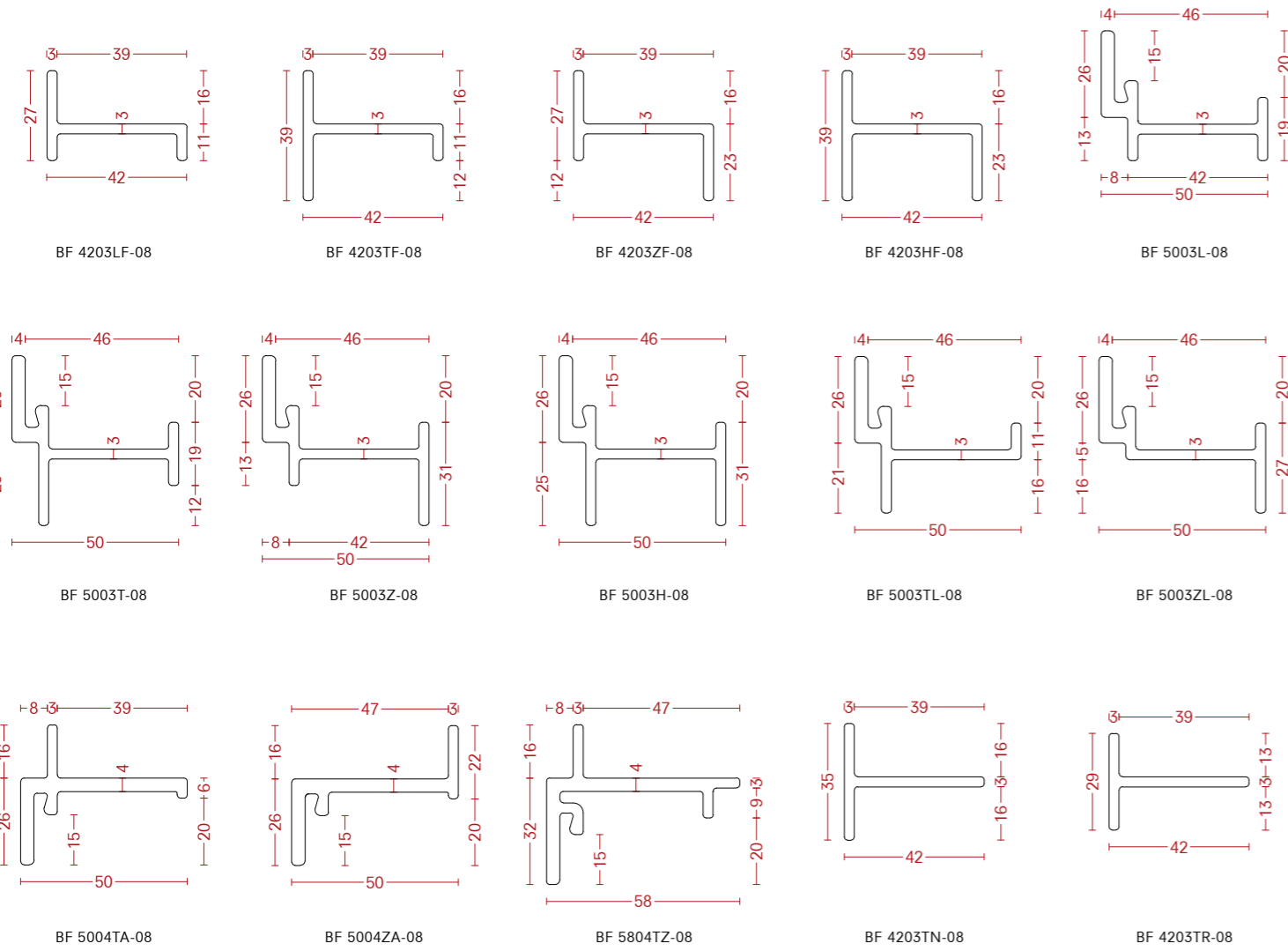

glazing beads

-08 Architectural bronze

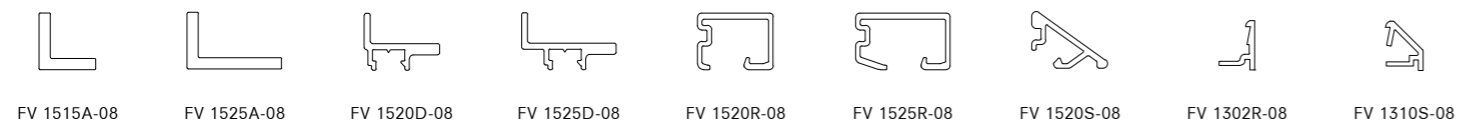

gaskets

-60 Black EPDM -61 Neoprene -62 PVC

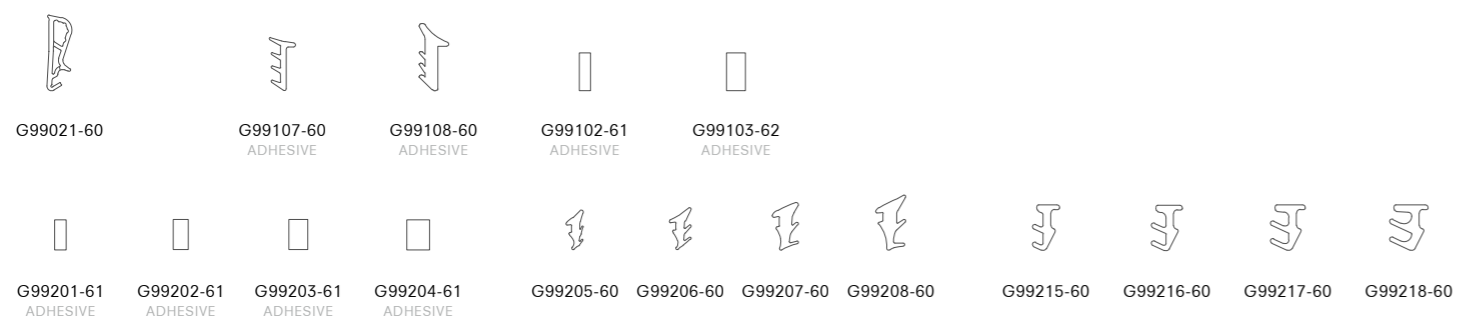

BronzoFinestra B75 TB

profile range

-05 Stainless steel AISI 316L 2B -08 Architectural bronze

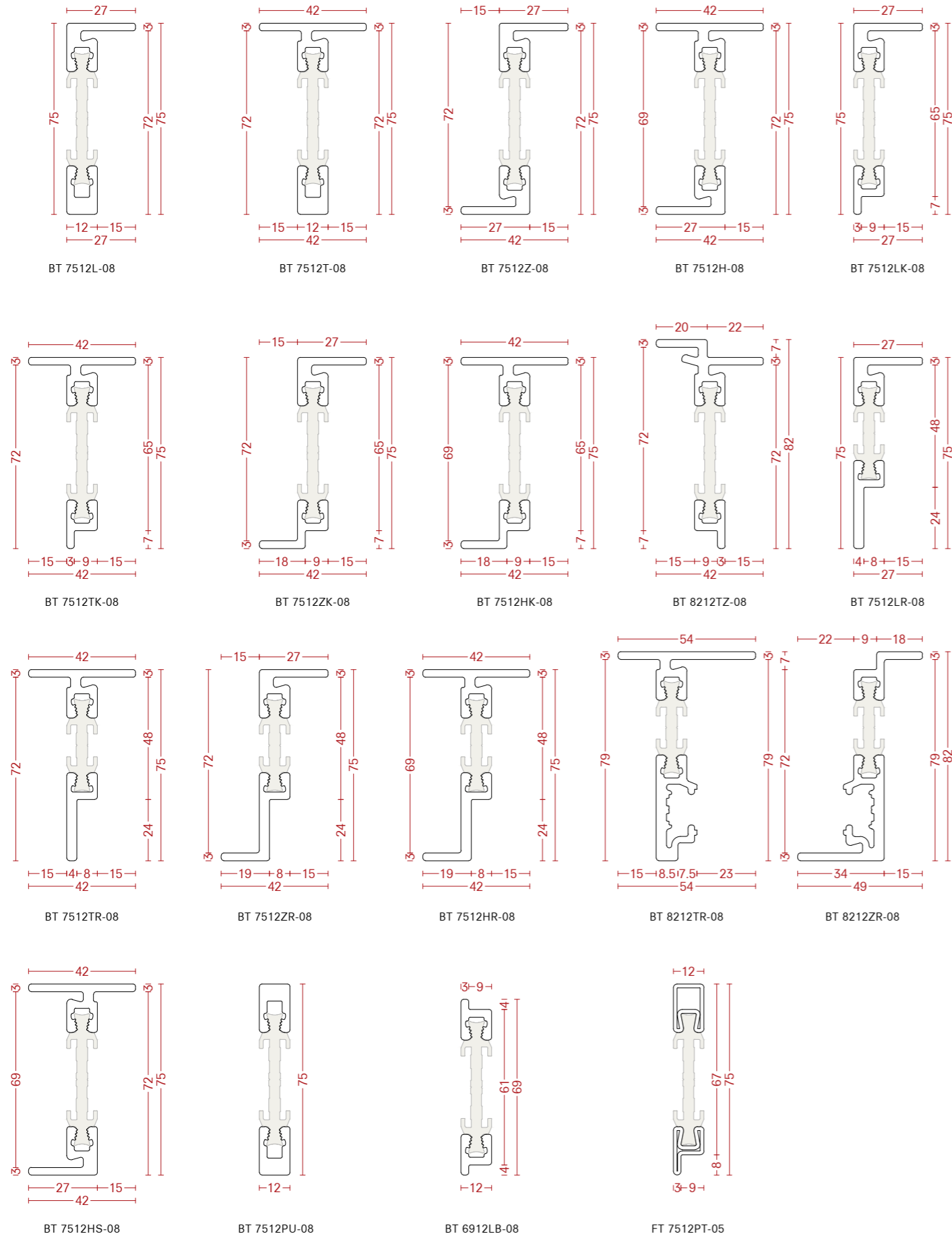

glazing beads

-08 Architectural bronze

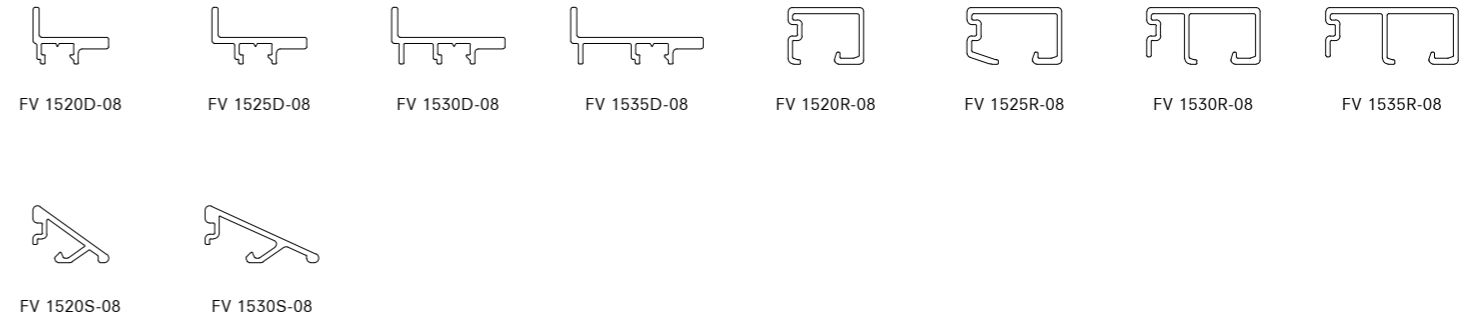

gaskets

-60 Black EPDM -61 Neoprene -62 PVC

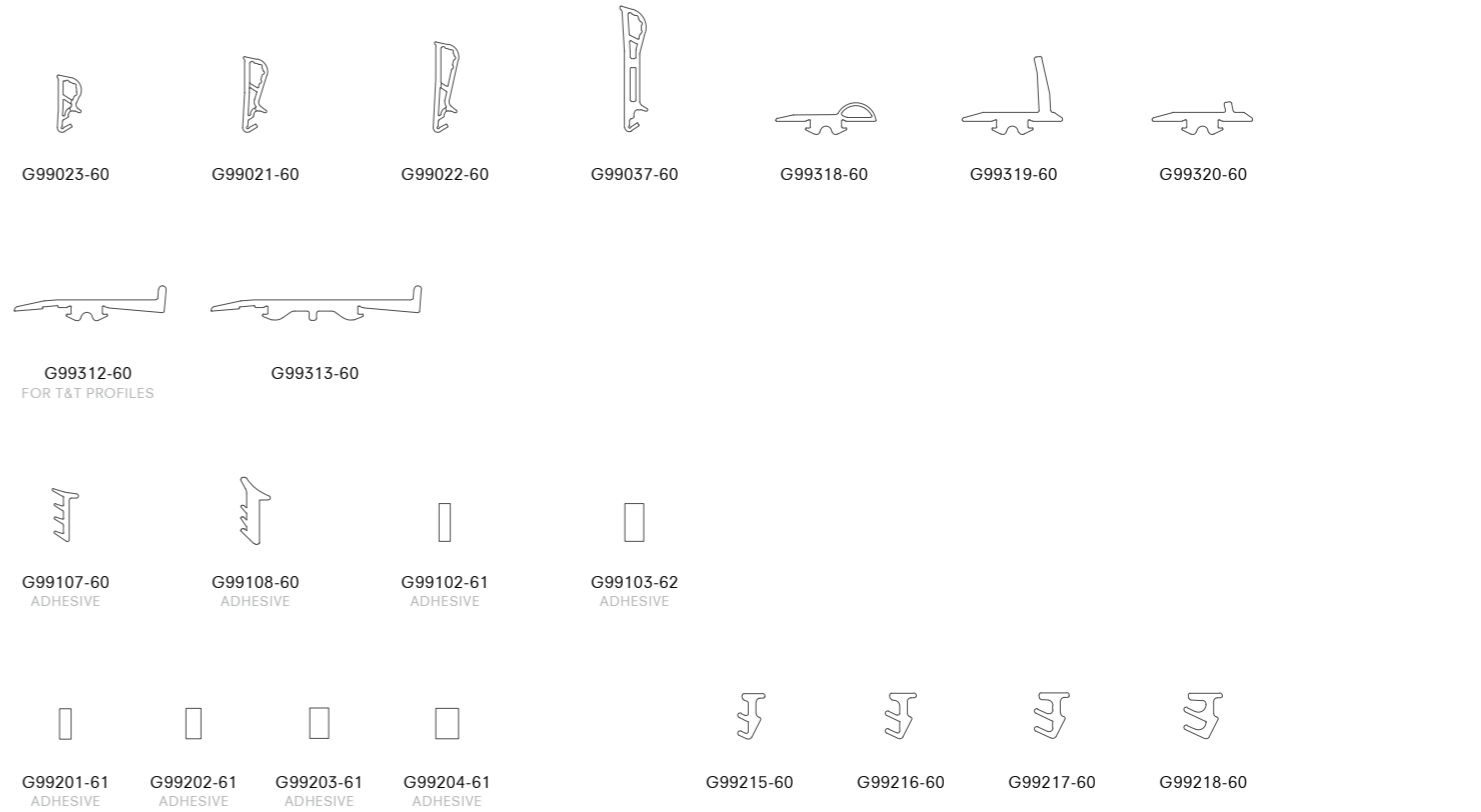

BronzoFinestra DB75 TB

profile range

-05 Stainless steel AISI 316L 2B -08 Architectural bronze

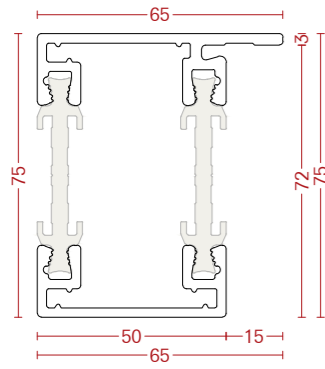

BT 7550LF-08

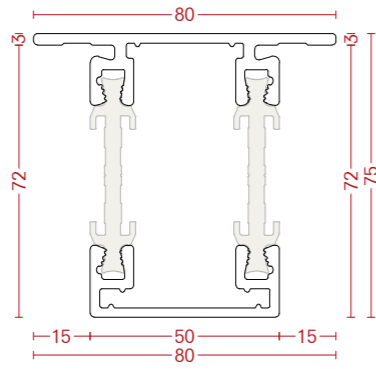

BT 7550TF-08

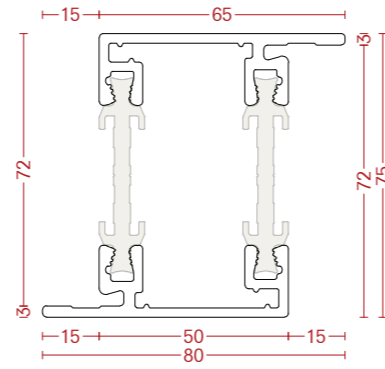

BT 7550ZF-08

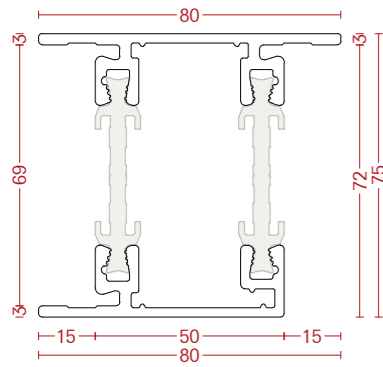

BT 7550HF-08

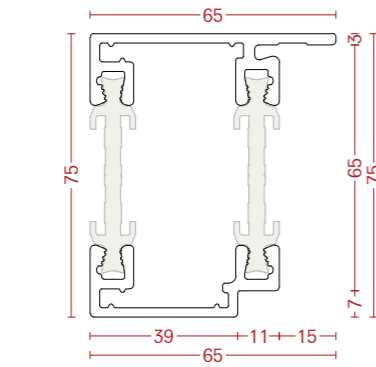

BT 7550L-08

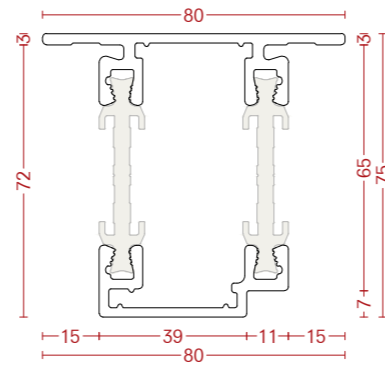

BT 7550T-08

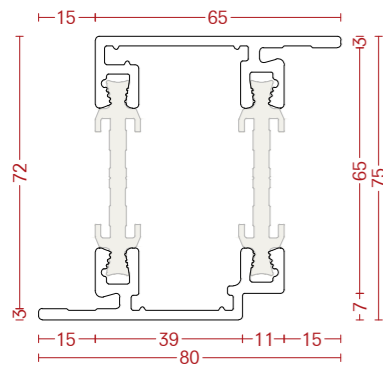

BT 7550Z-08

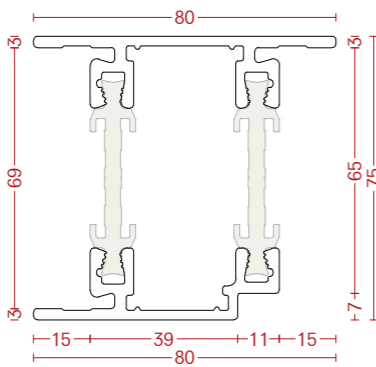

BT 7550H-08

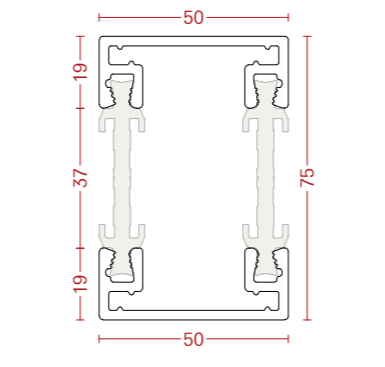

BT 7550PU-08

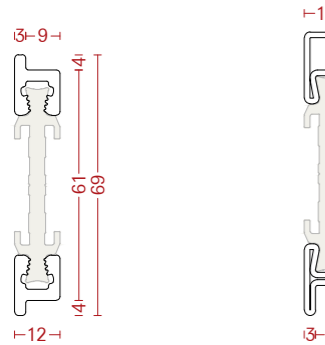

BT 6912LB-08

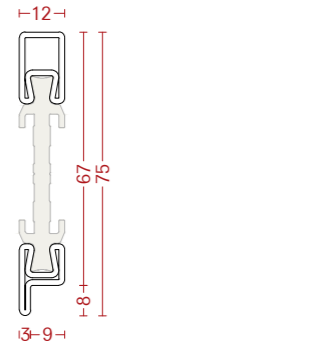

FT 7512PT-05

FOR GLAZING BEADS AND GASKETS, PLEASE SEE BRONZOFINESTRA B75 TB.



BronzoFinestra BLS75 TB - Lift&Slide

profile range

-06 Satin stainless steel AISI 316L -08 Architectural bronze -20 Satin brass -53 Aluminium electrocolor black
 -62 PVC -66 GRP

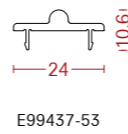
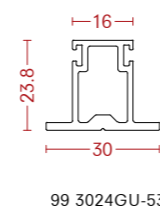
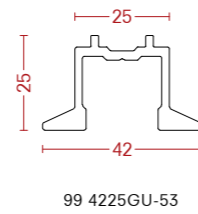
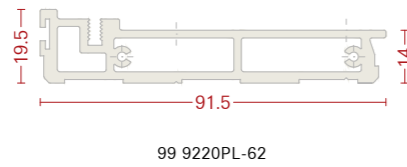
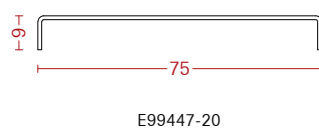
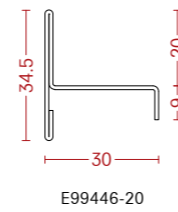
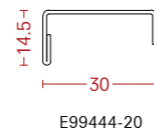
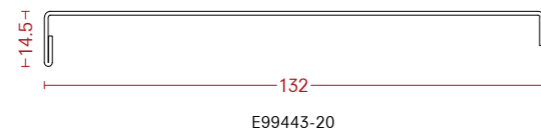
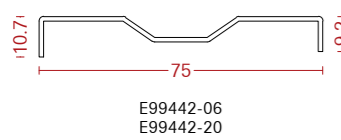
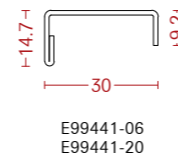
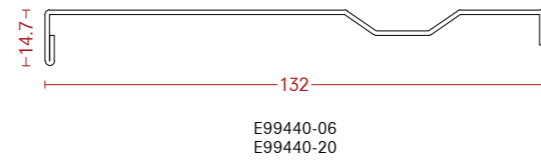
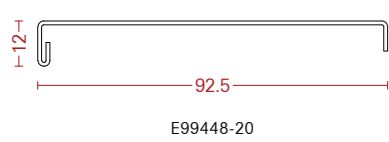
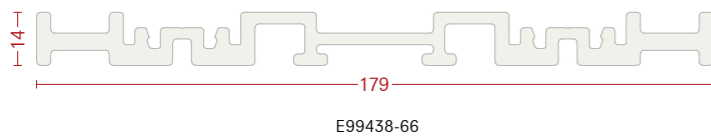
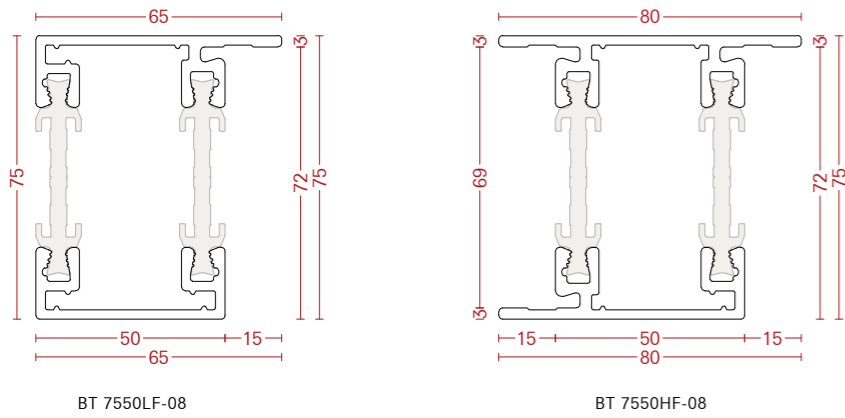
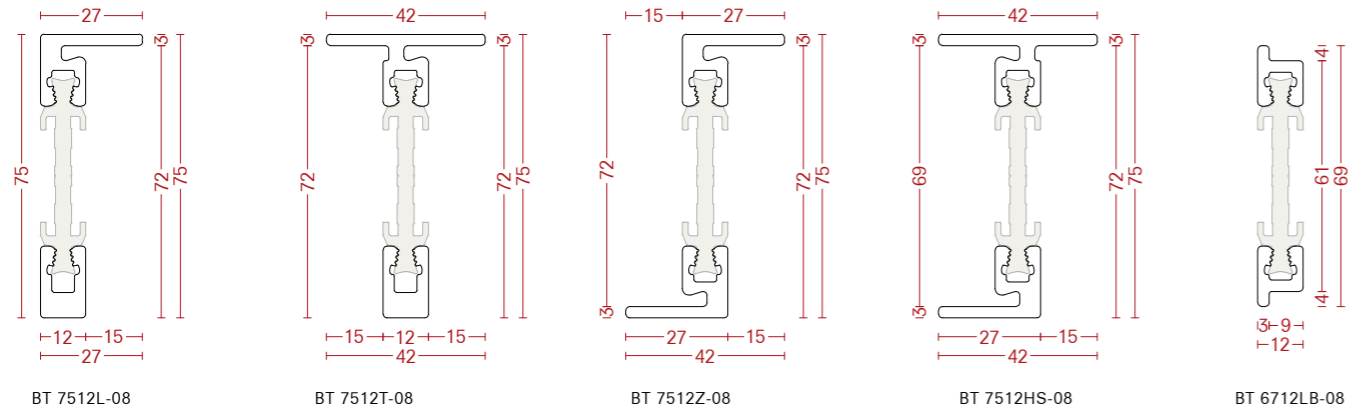

glazing beads

-08 Architectural bronze

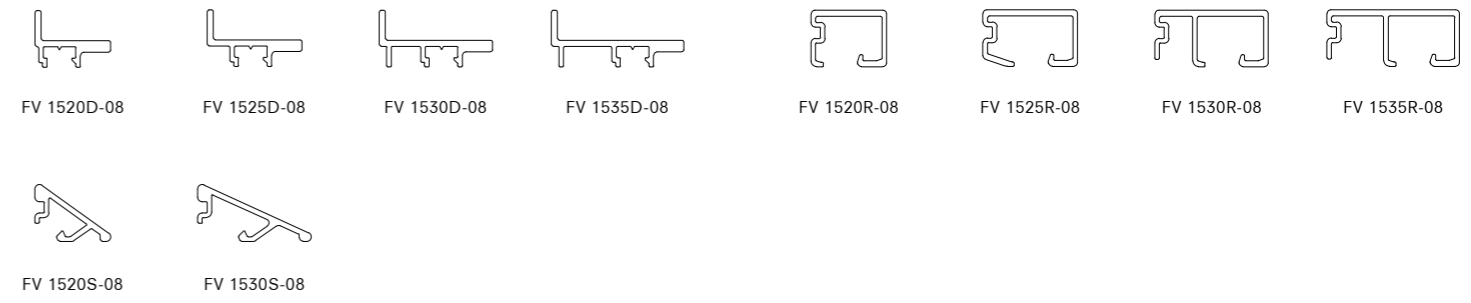

gaskets

-60 Black EPDM -61 Neoprene -62 PVC -64 Silicone

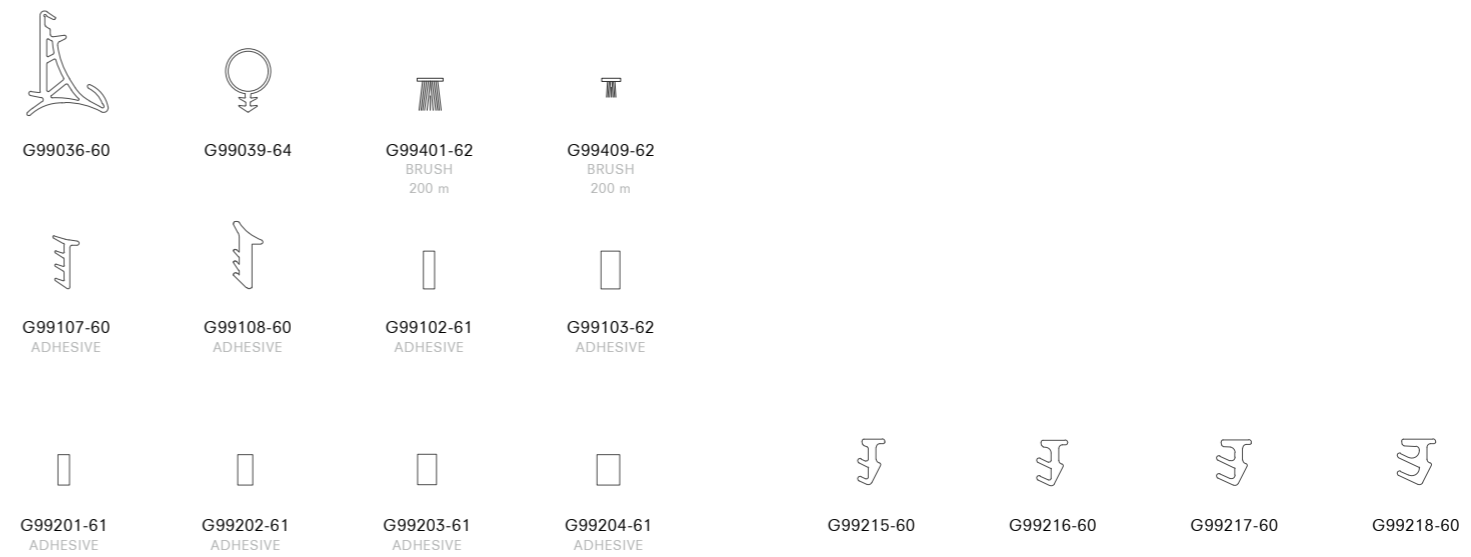

Mogs 2 mm Basic 50

profile range

D Bright steel Z Galvanized steel

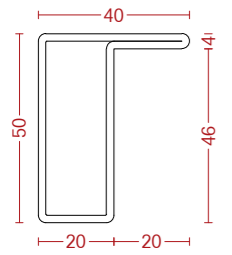

MF 5020L D
MF 5020L Z

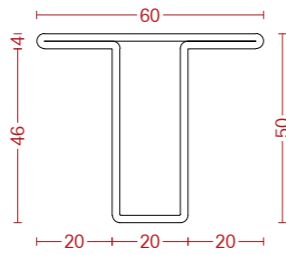

MF 5020T D
MF 5020T Z

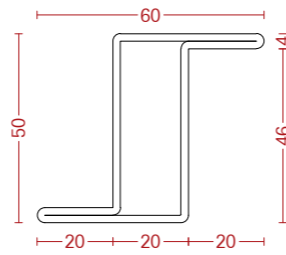

MF 5020Z D
MF 5020Z Z

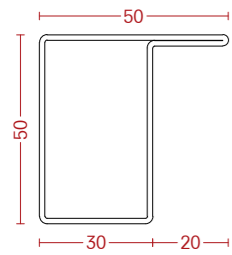

MF 5030L Z

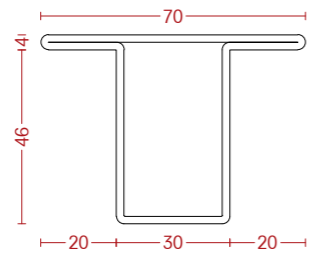

MF 5030T Z

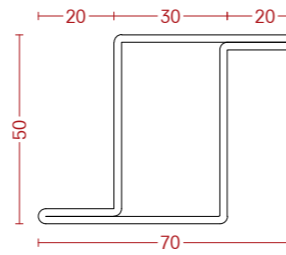

MF 5030Z Z

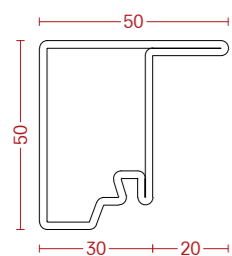

MF 5030LG D
MF 5030LG Z

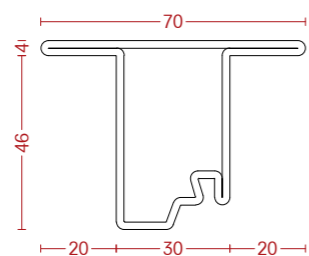

MF 5030TG D
MF 5030TG Z

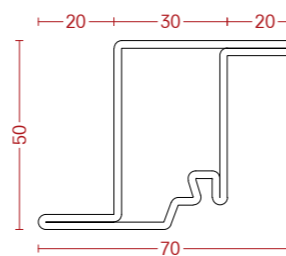

MF 5030ZG D
MF 5030ZG Z

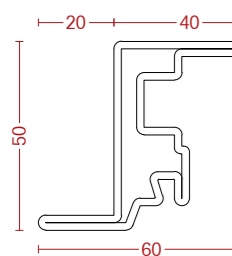

MF 5020ZG A/R Z
PROFILE FOR TILT AND TURN

complementary profiles

D Bright steel

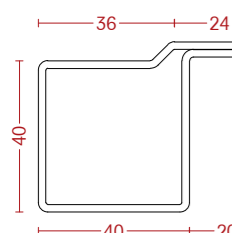

MF 4040LR D

profile range

D Bright steel Z Galvanized steel

*on request - minimum quantity required

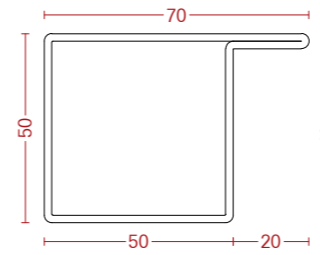

MF 5050L D
MF 5050L Z

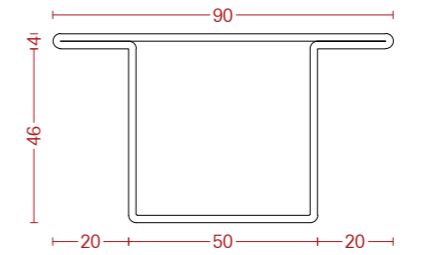

MF 5050T D
MF 5050T Z

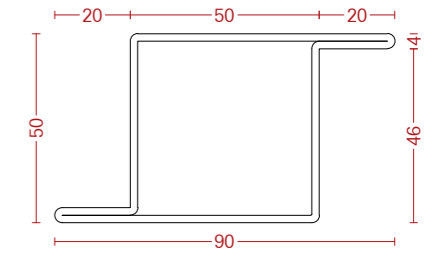

MF 5050Z D
MF 5050Z Z

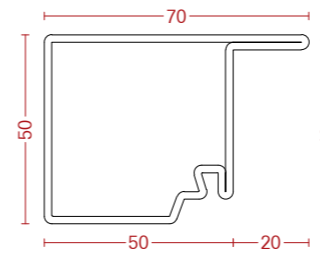

MF 5050LG D
MF 5050LG Z

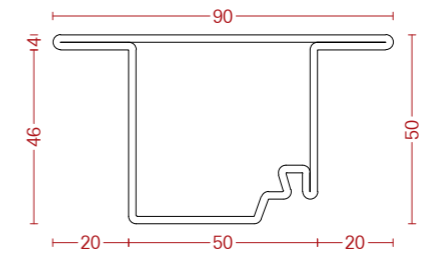

MF 5050TG D
MF 5050TG Z

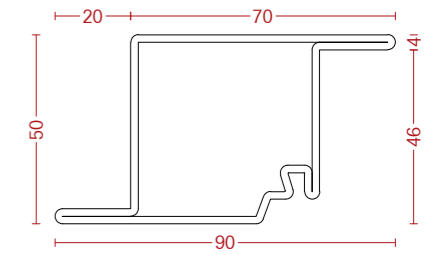

MF 5050ZG D
MF 5050ZG Z

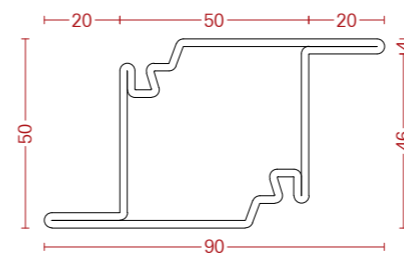

MF 5050Z2G Z *

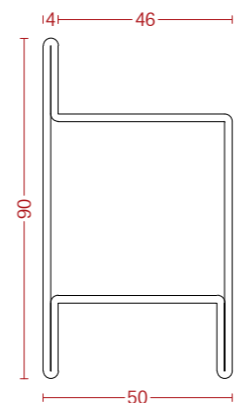

MF 5050H D
MF 5050H Z

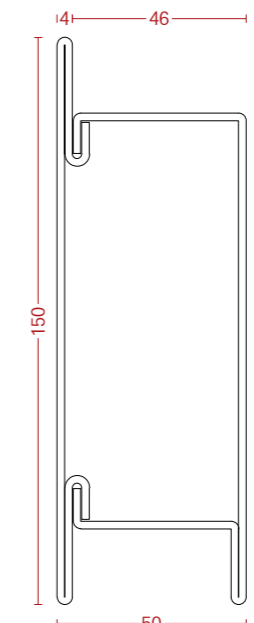

MF 50110ZOC Z *

Mogs 2 mm Basic 50

glazing beads

-02 Galvanized steel -12 Bright steel



FV 2015A-02



FV 2018L-02
FV 2018L-12

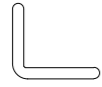

FV 2023L-02
FV 2023L-12

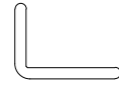

FV 2028L-02
FV 2028L-12

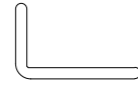

FV 2033L-02
FV 2033L-12



FV 2015R-02



FV 2018R-02

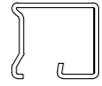

FV 2023R-02

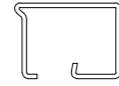

FV 2028R-02

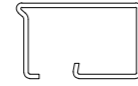

FV 2033R-02

gaskets

-60 Black EPDM -61 Neoprene



G99011-60



G12015-60



G99107-60
ADHESIVE



G99108-60
ADHESIVE



G99105-61
ADHESIVE



G99104-61
ADHESIVE



G99201-61
ADHESIVE



G99202-61
ADHESIVE



G99203-61
ADHESIVE



G99204-61
ADHESIVE



G99209-60



G99219-60



Mogs 2 mm Basic 60

profile range

Z Galvanized steel

*on request - minimum quantity required

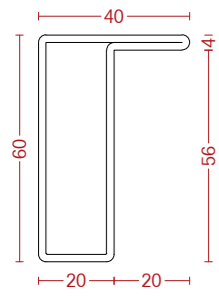

MF 6020L Z

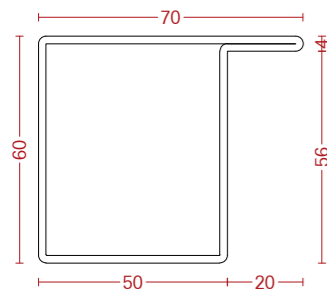

MF 6050L Z

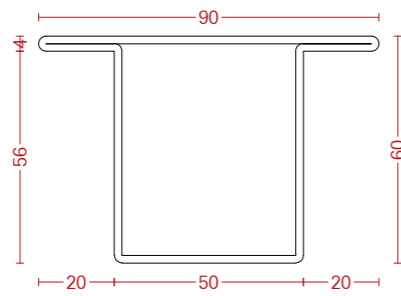

MF 6050T Z

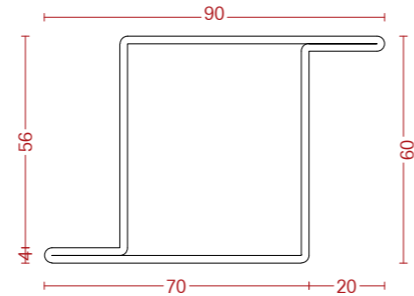

MF 6050Z Z

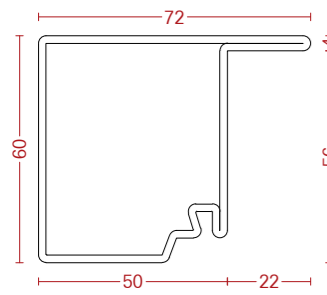

MF 6050LG Z

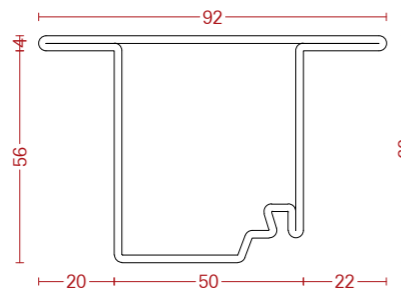

MF 6050TG Z

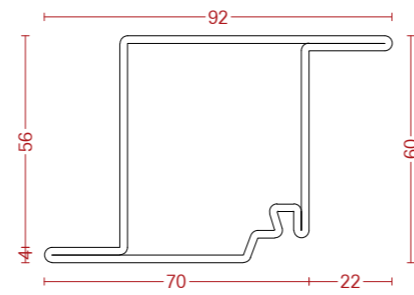

MF 6050ZG Z

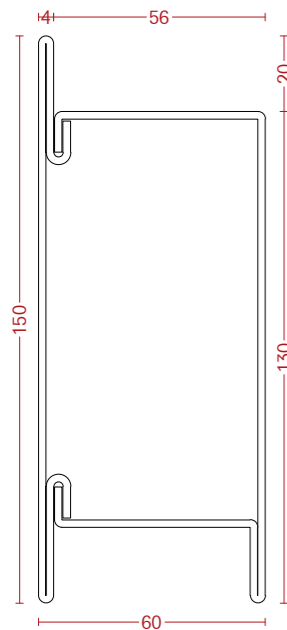

MF 60110ZOC Z *

glazing beads

-02 Galvanized steel



FV 2015A-02



FV 2018L-02

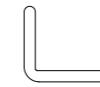

FV 2023L-02

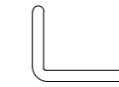

FV 2028L-02

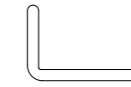

FV 2033L-02



FV 2015R-02



FV 2018R-02

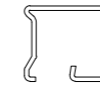

FV 2023R-02

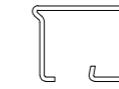

FV 2028R-02

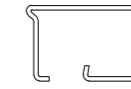

FV 2033R-02

gaskets

-60 Black EPDM

-61 Neoprene



G99011-60



G12015-60



G99107-60
ADHESIVE



G99108-60
ADHESIVE



G99105-61
ADHESIVE



G99104-61
ADHESIVE



G99201-61
ADHESIVE



G99202-61
ADHESIVE



G99203-61
ADHESIVE



G99204-61
ADHESIVE



G99209-60



G99219-60

Mogs 2 mm M65 TB

profile range

-02 Galvanized steel -05 Stainless steel AISI 316L 2B *on request - minimum quantity required
 -07 Cor-Ten steel -12 Bright steel -14 Laser welded and sand blasted steel
 -32 Laser welded and sand blasted Cor-Ten steel -34 Laser welded and sand blasted stainless steel AISI 316L

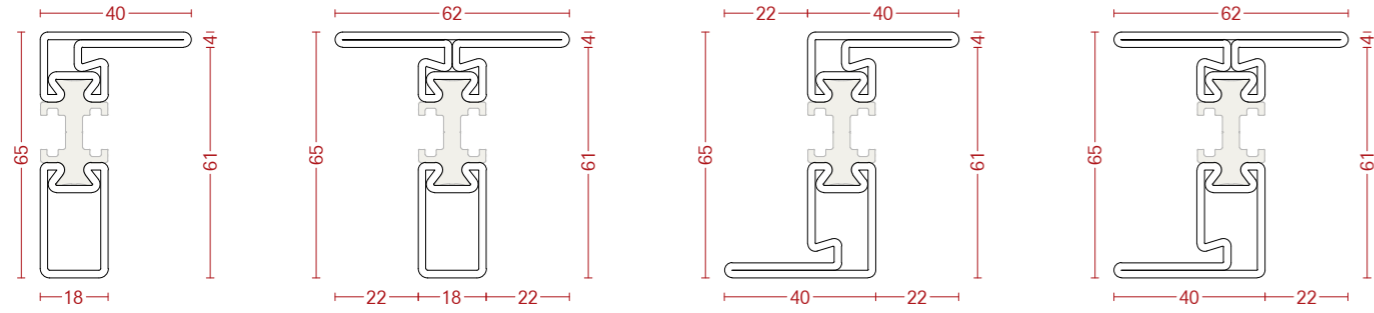

MT 6518L-02
MT 6518L-05
MT 6518L-07
MT 6518L-12

MT 6518T-02
MT 6518T-05
MT 6518T-07
MT 6518T-12

MT 6518Z-02
MT 6518Z-05
MT 6518Z-07
MT 6518Z-12

MT 6518H-02
MT 6518H-05
MT 6518H-07
MT 6518H-12

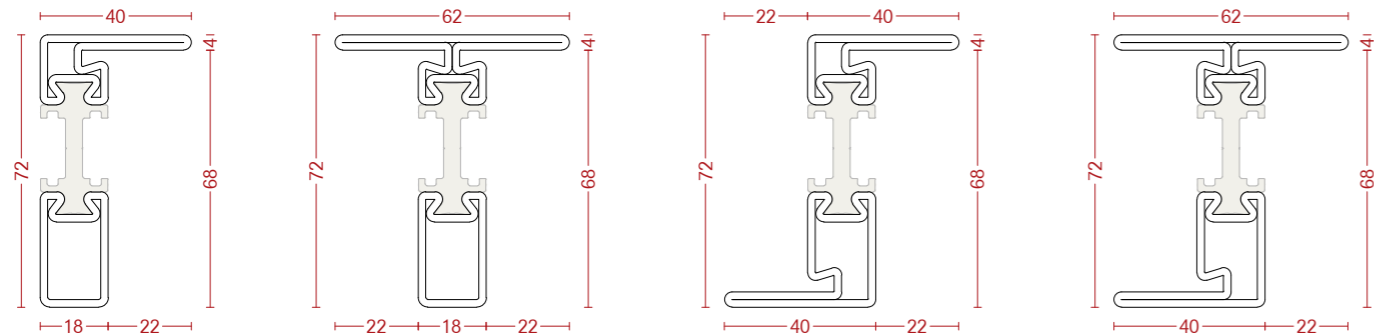

MT 7218LF-02
MT 7218LF-05
MT 7218LF-07
MT 7218LF-12

MT 7218TF-02
MT 7218TF-05
MT 7218TF-07
MT 7218TF-12

MT 7218ZF-02
MT 7218ZF-05
MT 7218ZF-07
MT 7218ZF-12

MT 7218HF-02
MT 7218HF-05
MT 7218HF-07
MT 7218HF-12

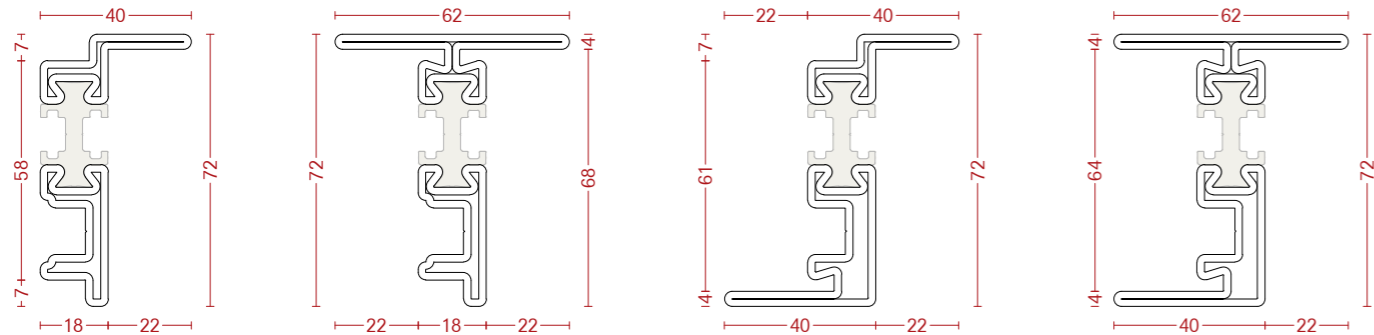

MT 7218LR-02
MT 7218LR-05
MT 7218LR-07
MT 7218LR-12

MT 7218TZ-02
MT 7218TZ-05
MT 7218TZ-07
MT 7218TZ-12

MT 7218ZR-02
MT 7218ZR-05
MT 7218ZR-07
MT 7218ZR-12

MT 7218HZ-02
MT 7218HZ-05
MT 7218HZ-07
MT 7218HZ-12

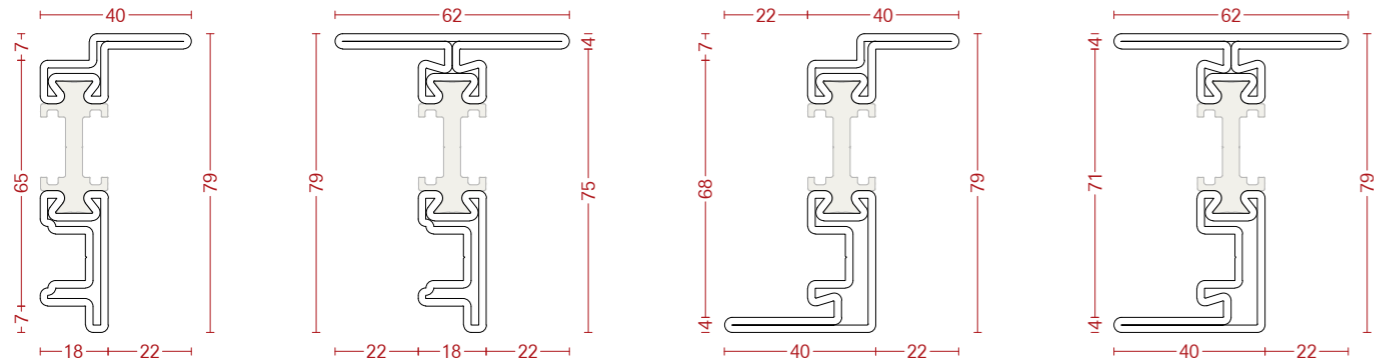

MT 7918LR-02 *
MT 7918LR-05 *
MT 7918LR-07 *
MT 7918LR-12 *

MT 7918TZ-02 *
MT 7918TZ-05 *
MT 7918TZ-07 *
MT 7918TZ-12 *

MT 7918ZR-02 *
MT 7918ZR-05 *
MT 7918ZR-07 *
MT 7918ZR-12 *

MT 7918HZ-02 *
MT 7918HZ-05 *
MT 7918HZ-07 *
MT 7918HZ-12 *

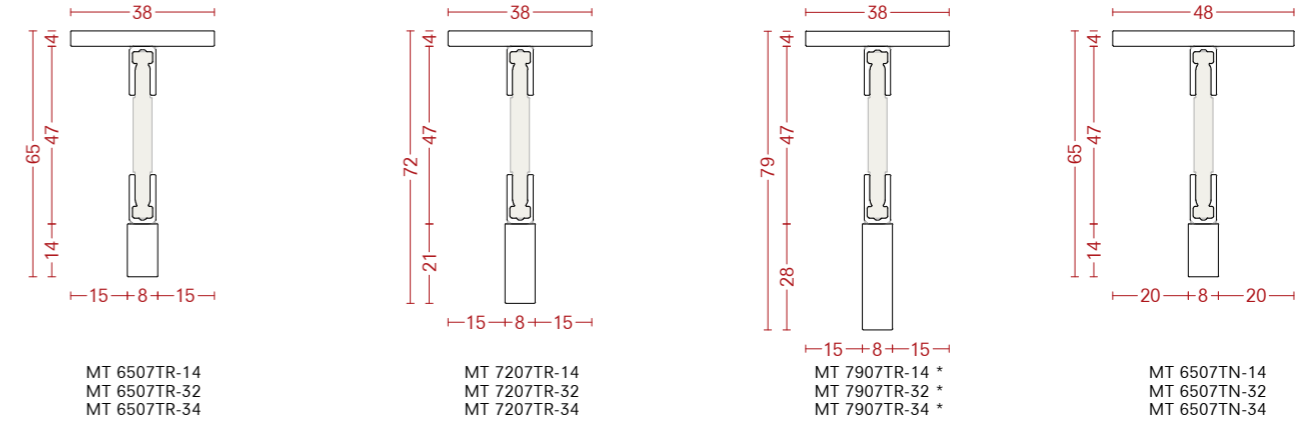

MT 6507TR-14
MT 6507TR-32
MT 6507TR-34

MT 7207TR-14
MT 7207TR-32
MT 7207TR-34

MT 7907TR-14 *
MT 7907TR-32 *
MT 7907TR-34 *

MT 6507TN-14
MT 6507TN-32
MT 6507TN-34

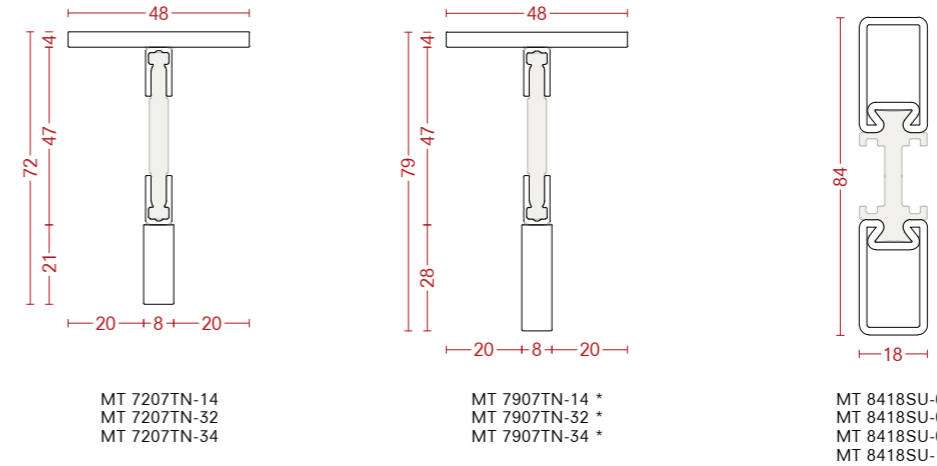

MT 7207TN-14
MT 7207TN-32
MT 7207TN-34

MT 7907TN-14 *
MT 7907TN-32 *
MT 7907TN-34 *

MT 8418SU-02
MT 8418SU-05
MT 8418SU-07
MT 8418SU-12

glazing beads

-02 Galvanized steel -06 Satin stainless steel AISI 316L -07 Cor-Ten steel -12 Bright steel

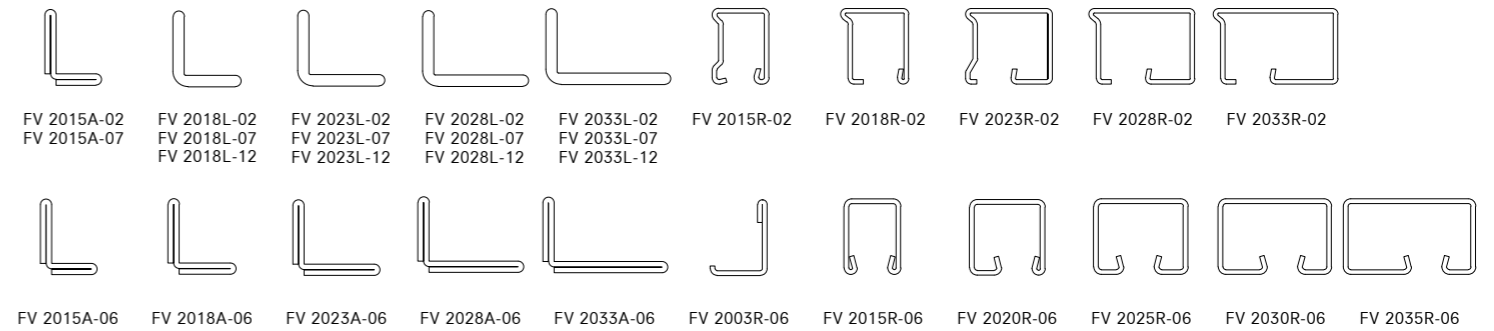

FV 2015A-02
FV 2015A-07

FV 2018L-02
FV 2018L-07
FV 2018L-12

FV 2023L-02
FV 2023L-07
FV 2023L-12

FV 2028L-02
FV 2028L-07
FV 2028L-12

FV 2033L-02
FV 2033L-07
FV 2033L-12

FV 2015R-02

FV 2018R-02

FV 2023R-02

FV 2028R-02

FV 2033R-02

FV 2015A-06

FV 2018A-06

FV 2023A-06

FV 2028A-06

FV 2033A-06

FV 2003R-06

FV 2015R-06

FV 2020R-06

FV 2025R-06

FV 2030R-06

FV 2035R-06

gaskets

-60 Black EPDM -61 Neoprene

*on request - minimum quantity required

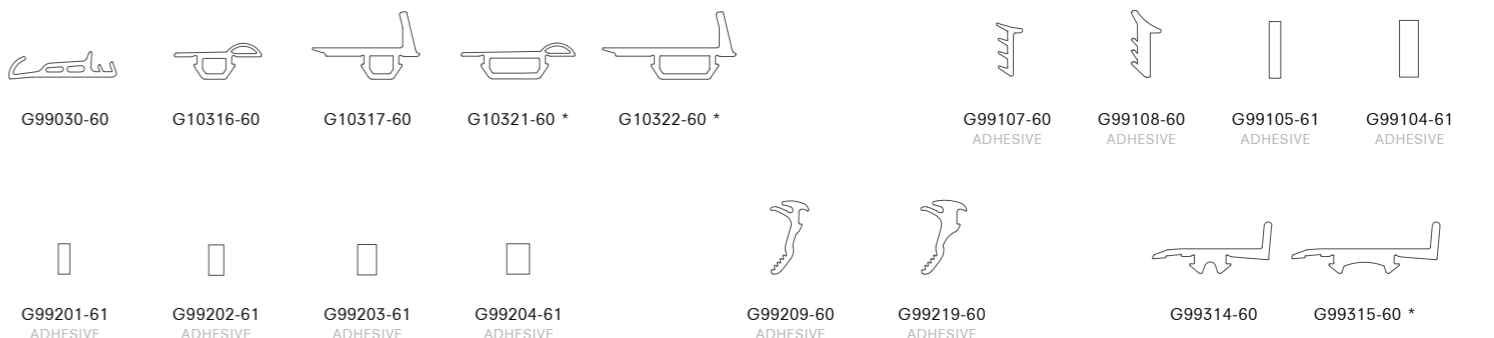

G99030-60

G10316-60

G10317-60

G10321-60 *

G10322-60 *

G99107-60
ADHESIVE

G99108-60
ADHESIVE

G99105-61
ADHESIVE

G99104-61
ADHESIVE

G99201-61
ADHESIVE

G99202-61
ADHESIVE

G99203-61
ADHESIVE

G99204-61
ADHESIVE

G99209-60
ADHESIVE

G99219-60
ADHESIVE

G99314-60

G99315-60 *

Mogs 2 mm MLS72 TB - Lift&Slide

profile range

-00 Aluminium -02 Galvanized steel -05 Stainless steel AISI 316L 2B
 -06 Satin stainless steel AISI 316L -07 Cor-Ten steel
 -53 Aluminium electrocolor black -62 PVC

*on request - minimum quantity required

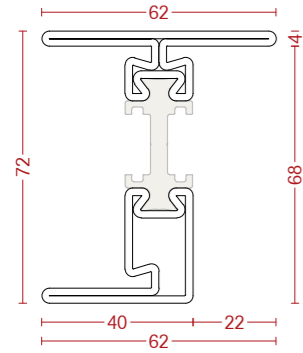

MT 7218HF-02
 MT 7218HF-05
 MT 7218HF-07

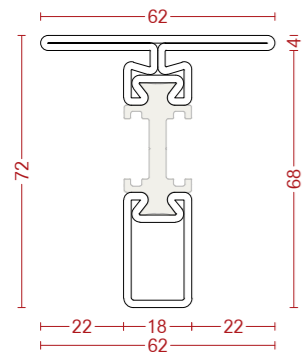

MT 7218TF-02
 MT 7218TF-05
 MT 7218TF-07

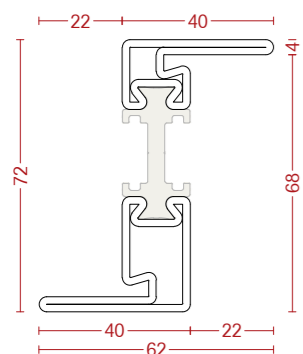

MT 7218ZF-02
 MT 7218ZF-05
 MT 7218ZF-07

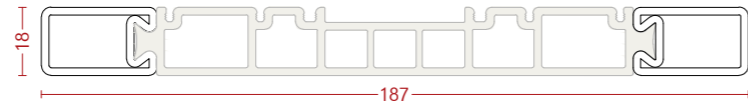

MT 18718CI-05
 MT 18718CI-07 *

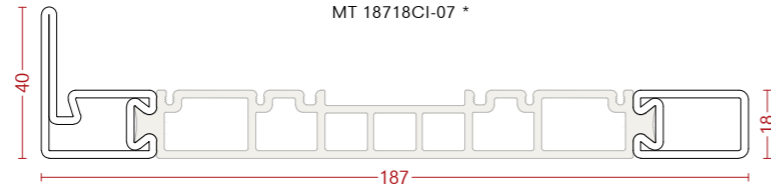

MT 18718CL-02
 MT 18718CL-05
 MT 18718CL-07

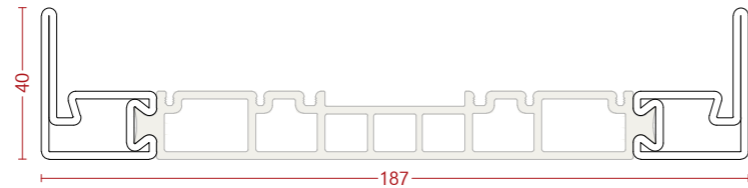

MT 18718CU-02
 MT 18718CU-05
 MT 18718CU-07

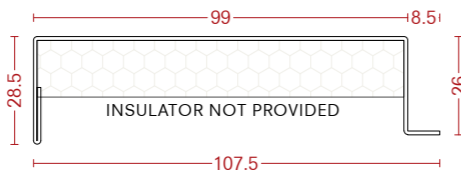

E99403-02
 E99403-06
 E99403-07
 E99404-02
 E99404-06

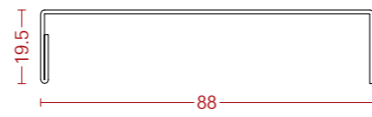

E99405-02
 E99405-06
 E99405-07
 E99406-02
 E99406-06

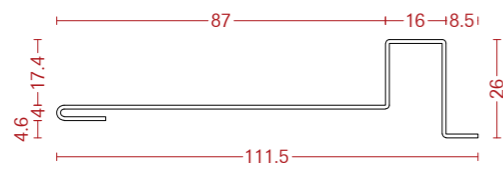

E99408-02
 E99408-06
 E99408-07
 E99409-02
 E99409-06

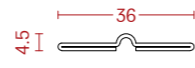

E99401-06

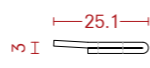

E99412-05

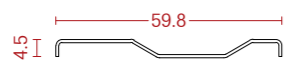

E99435-06

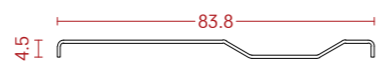

E99436-06

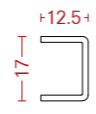

E99430-02

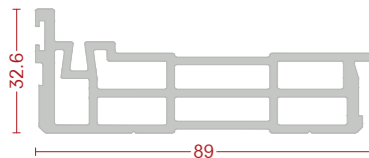

99 8933PL-62

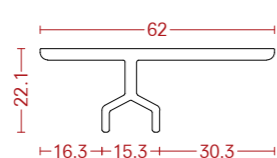

99 6222GU-53

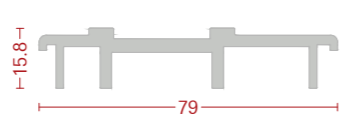

99 7916PL-62

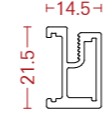

99 2215PG-00

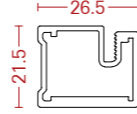

99 2227PG-00

glazing beads

-02 Galvanized steel -06 Satin stainless steel AISI 316L -07 Cor-Ten steel

*on request - minimum quantity required



FV 2015A-02
 FV 2015A-07



FV 2018L-02
 FV 2018L-07

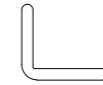

FV 2023L-02
 FV 2023L-07



FV 2015R-02



FV 2020R-02

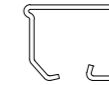

FV 2025R-02

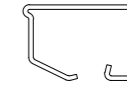

FV 2030R-02



FV 2018R-02



FV 2023R-02



FV 2015A-06



FV 2018A-06

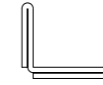

FV 2023A-06



FV 2003R-06



FV 2015R-06



FV 2020R-06

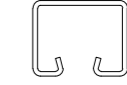

FV 2025R-06

gaskets

-60 Black EPDM -61 Neoprene -62 PVC -64 Silicone -83 TPE



G99026-83



G99028-83



G99027-83



G99031-64
 CORNER



G99032-64
 CORNER



G99033-64
 CORNER



G12015-60



G99401-62
 BRUSH



G99107-60
 ADHESIVE



G99108-60
 ADHESIVE



G99105-61
 ADHESIVE



G99104-61
 ADHESIVE



G99201-61
 ADHESIVE



G99202-61
 ADHESIVE



G99203-61
 ADHESIVE



G99204-61
 ADHESIVE



G99209-60



G99219-60



W40 Fire

profile range

-01 Hot rolled steel -14 Laser welded and sand blasted steel

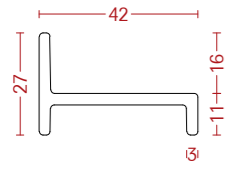

FF 4203LF-01

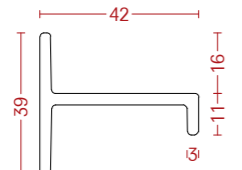

FF 4203TF-01

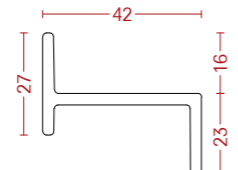

FF 4203ZF-01

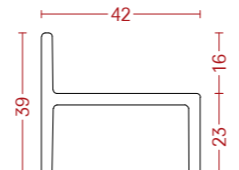

FF 4203HF-01

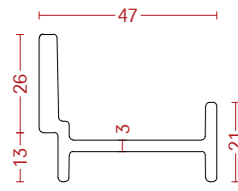

FF 4703L-01

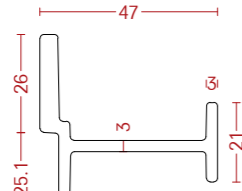

FF 4703T-01

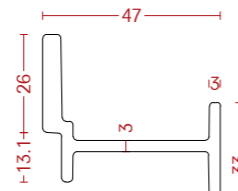

FF 4703Z-01

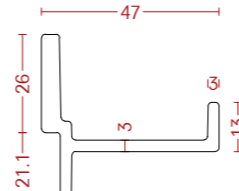

FF 4703TL-01

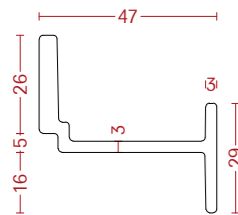

FF 4703ZL-01

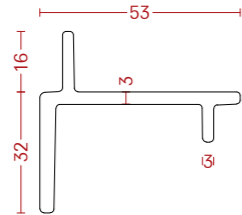

FF 5303TZ-01

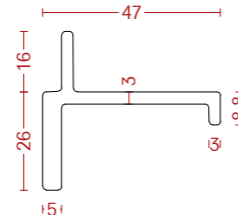

FF 4703TA-01

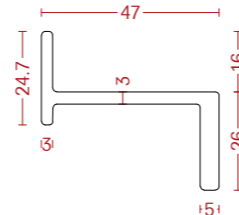

FF 4703ZA-01

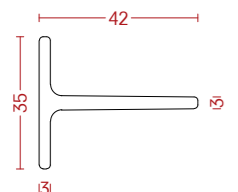

FF 4203TN-01

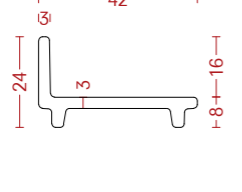

FF 4203LC-01

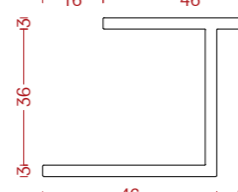

FF 4203RS-14

glazing beads

-01 Hot rolled steel



FV 1616A-01

rebate gaskets

-81 black -84 black



G99953-81
ADHESIVE



G99956-84
ADHESIVE

internal profile gaskets

-81 black



G99951-81
ADHESIVE

glass - internal/external gaskets

-79 white -82 black

*on request - minimum quantity required



G99950-82
ADHESIVE



G99950-79 *
ADHESIVE



G99954-79 *
ADHESIVE



G99955-79 *
ADHESIVE

under glass gaskets

-80 black



G99952-80
ADHESIVE

end pieces for second leaf

-12 Bright steel

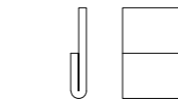

E03302-12

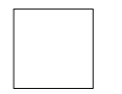
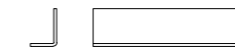

E03303-12

automatic drop seal

-62 PVC

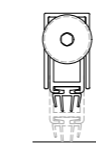

G995XX-62
AUTOMATIC
DROP SEAL

Code	Length	Can be shortened
G99501-62	330 mm	50 mm
G99502-62	430 mm	135 mm
G99503-62	530 mm	200 mm
G99504-62	630 mm	200 mm
G99505-62	730 mm	200 mm
G99506-62	830 mm	200 mm
G99507-62	930 mm	200 mm
G99508-62	1030 mm	200 mm
G99509-62	1130 mm	200 mm
G99510-62	1230 mm	200 mm

Custom CPX TB

profile range

-03 Stainless steel AISI 304 2B

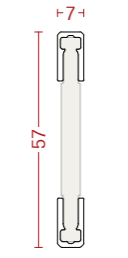

CP 5707IB-03

examples of laser welded custom profiles

-33 Laser welded and sand blasted stainless steel AISI 304L

-34 Laser welded and sand blasted stainless steel AISI 316L

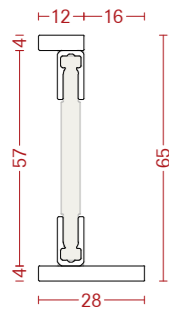

CP 6507LF-33
CP 6507LF-34

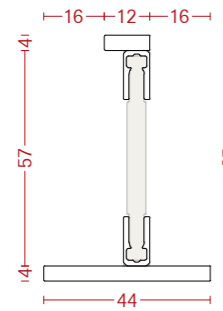

CP 6507TU-33
CP 6507TU-34

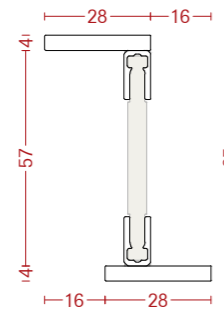

CP 6507ZU-33
CP 6507ZU-34

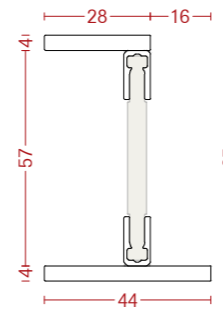

CP 6507HF-33
CP 6507HF-34

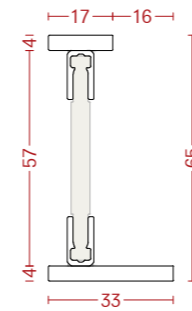

CP 6507L-33
CP 6507L-34

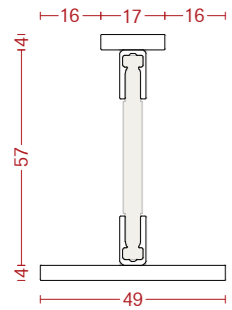

CP 6507TD-33
CP 6507TD-34

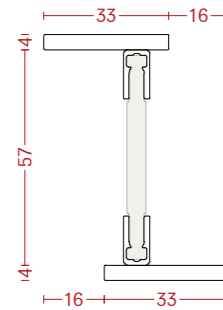

CP 6507Z-33
CP 6507Z-34

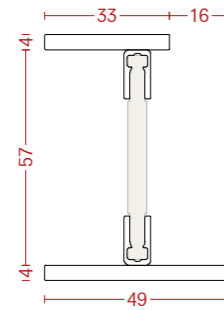

CP 6507H-33
CP 6507H-34

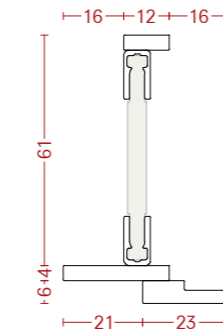

CP 7107TZ-33
CP 7107TZ-34

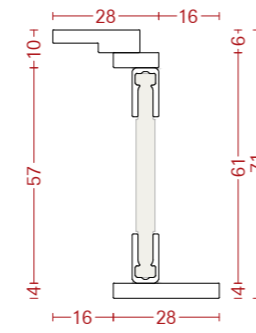

CP 7107ZA-33
CP 7107ZA-34

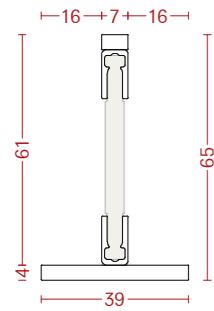

CP 6507TN-33
CP 6507TN-34

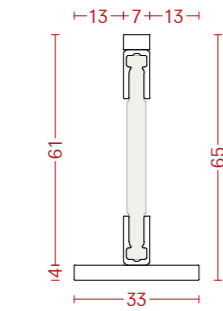

CP 6507TR-33
CP 6507TR-34

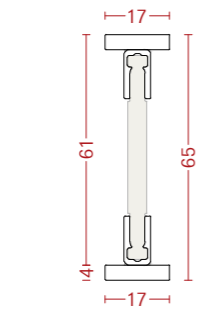

CP 6507SU-33
CP 6507SU-34

glazing beads

-04 Satin stainless steel AISI 304

-06 Satin stainless steel AISI 316L

*on request - minimum quantity required

-33 Laser welded and sand blasted stainless steel AISI 304L

-34 Laser welded and sand blasted stainless steel AISI 316L



FV 1618A-04
FV 1618A-06 *



FV 1623A-04
FV 1623A-06 *

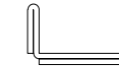

FV 1628A-04
FV 1628A-06 *

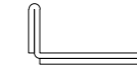

FV 1633A-04
FV 1633A-06 *

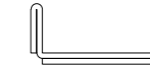

FV 1638A-04
FV 1638A-06 *



FV 1643A-04
FV 1643A-06 *



FV 1313A-33 *
FV 1313A-34 *



FV 1316A-33 *
FV 1316A-34 *



FV 1616A-33 *
FV 1616A-34 *

gaskets

-60 Black EPDM

-61 Neoprene

-62 PVC



G99019-60
ADHESIVE



G99102-61
ADHESIVE



G99103-62
ADHESIVE



G99201-61
ADHESIVE



G99202-61
ADHESIVE



G99203-61
ADHESIVE



G99204-61
ADHESIVE

FerroFinestra T42 TB

profile range

-14 Laser welded and sand blasted steel -33 Laser welded and sand blasted stainless steel AISI 304L
 -34 Laser welded and sand blasted stainless steel AISI 316L

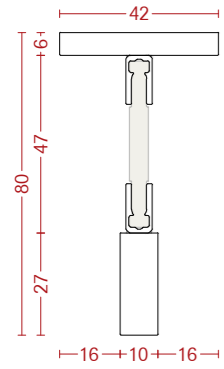

FT 801042TF-14
 FT 801042TF-33
 FT 801042TF-34

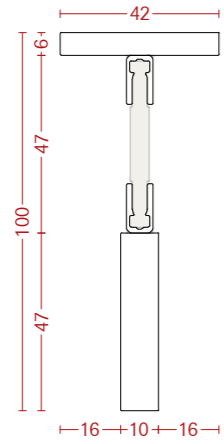

FT 1001042TF-14
 FT 1001042TF-33
 FT 1001042TF-34

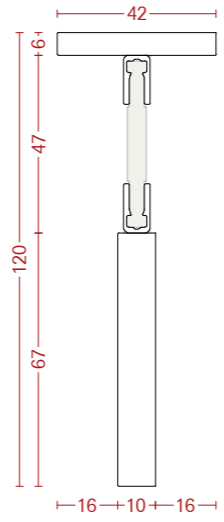

FT 1201042TF-14
 FT 1201042TF-33
 FT 1201042TF-34

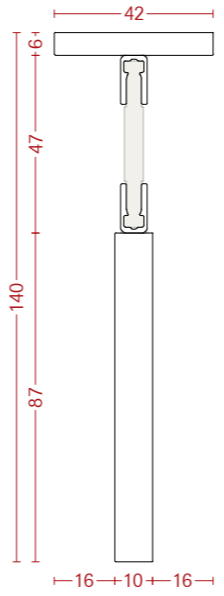

FT 1401042TF-14
 FT 1401042TF-33
 FT 1401042TF-34

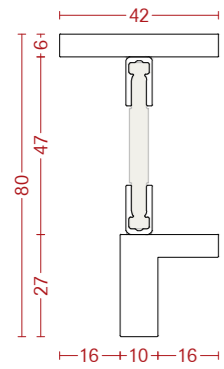

FT 801042HF-14
 FT 801042HF-33
 FT 801042HF-34

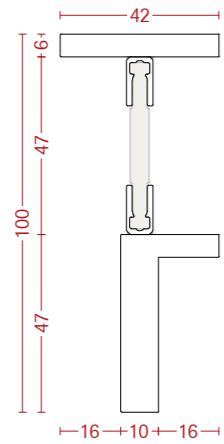

FT 1001042HF-14
 FT 1001042HF-33
 FT 1001042HF-34

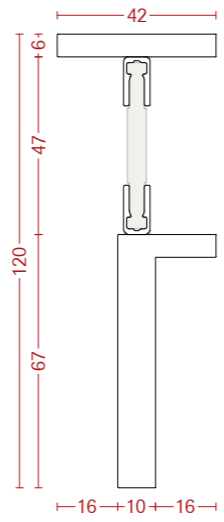

FT 1201042HF-14
 FT 1201042HF-33
 FT 1201042HF-34

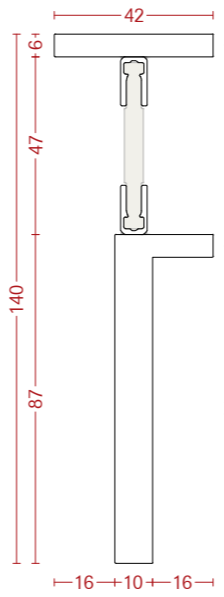

FT 1401042HF-14
 FT 1401042HF-33
 FT 1401042HF-34

glazing beads

-01 Hot rolled steel -02 Galvanized steel -04 Satin stainless steel AISI 304 *on request - minimum quantity required
 -05 Stainless steel AISI 316L 2B -06 Satin stainless steel AISI 316L



FV 1618A-02
 FV 1618A-04
 FV 1618A-06 *



FV 1623A-02
 FV 1623A-04
 FV 1623A-06 *



FV 1628A-02
 FV 1628A-04
 FV 1628A-06 *



FV 1633A-02
 FV 1633A-04
 FV 1633A-06 *



FV 1638A-02
 FV 1638A-04
 FV 1638A-06 *



FV 1643A-02
 FV 1643A-04
 FV 1643A-06 *



FV 1515A-02



FV 1815A-02



FV 1616A-01



FV 1625A-01



FV 1515D-02 *



FV 1520E-02
 FV 1520E-05



FV 1525E-02
 FV 1525E-05



FV 1530E-02
 FV 1530E-05



FV 1535E-02
 FV 1535E-05

gaskets

-61 Neoprene -62 PVC



G99102-61
 ADHESIVE



G99103-62
 ADHESIVE



G99201-61
 ADHESIVE



G99202-61
 ADHESIVE



G99203-61
 ADHESIVE



G99204-61
 ADHESIVE

Curtain Walls CW50 TB

mullions and transoms with screwing groove

Galvanized steel

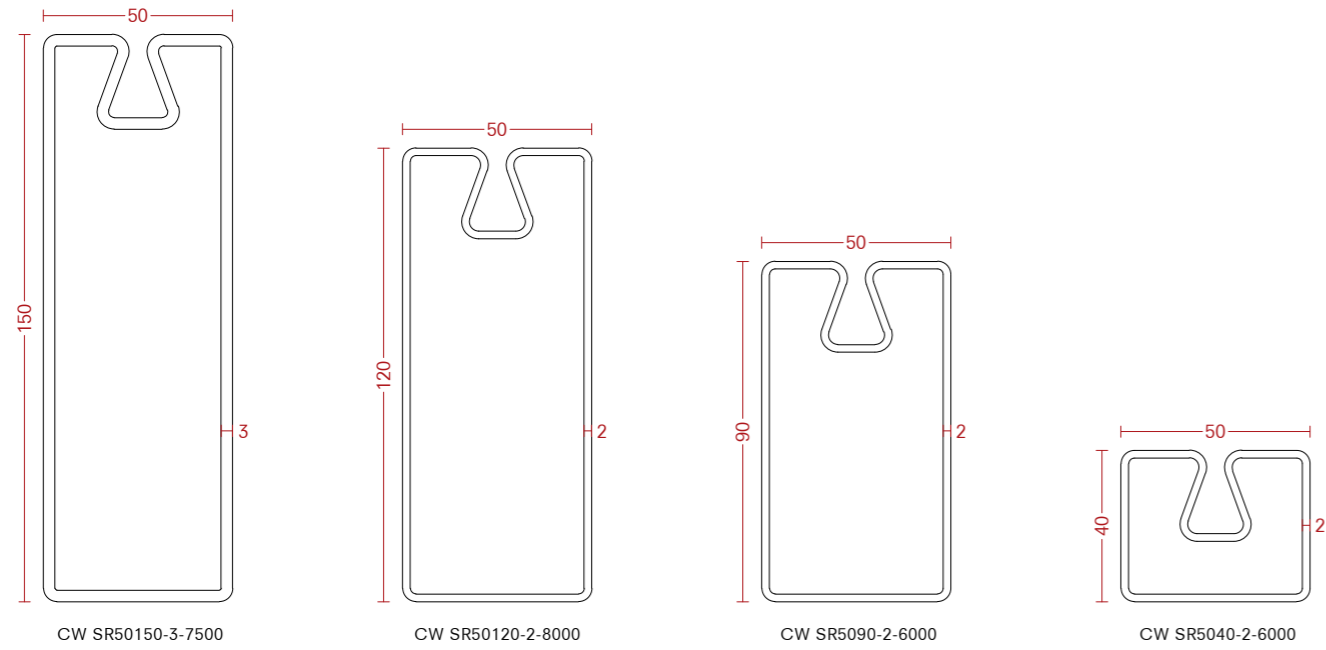

transom connectors and adapter profiles

Aluminum

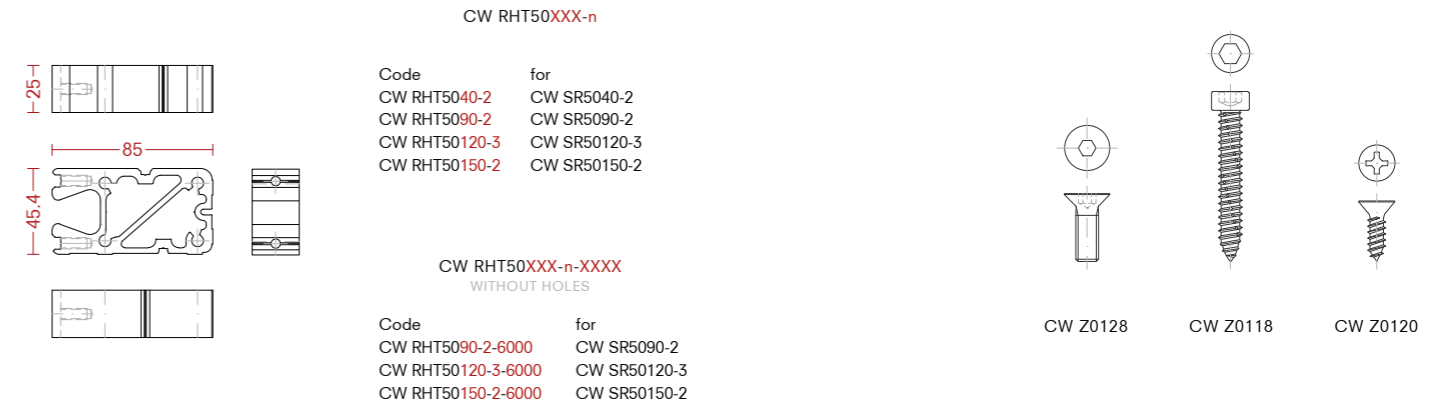

snap-on cover caps

Aluminum

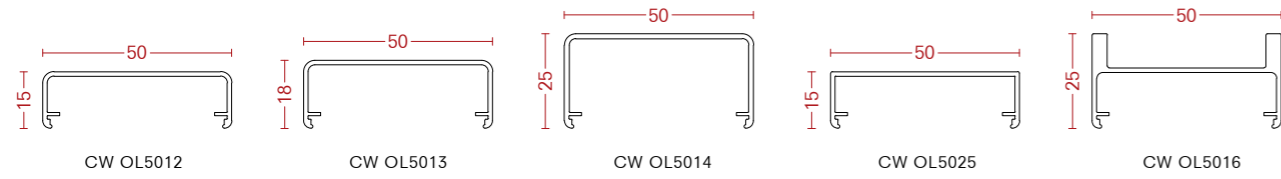

pressure plates

Aluminum

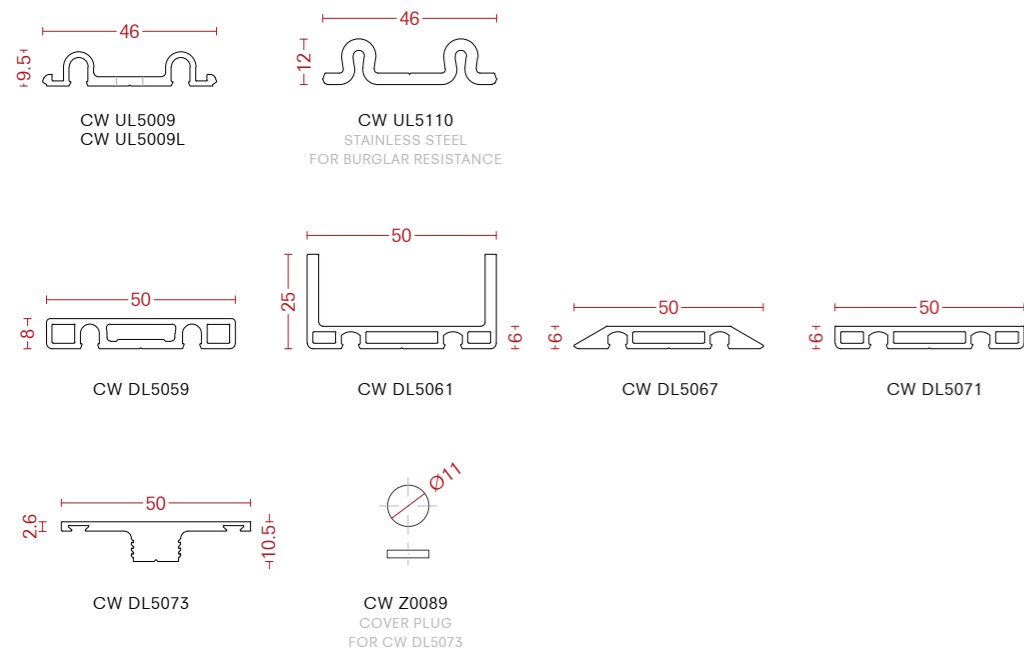

glass supports

Aluminum

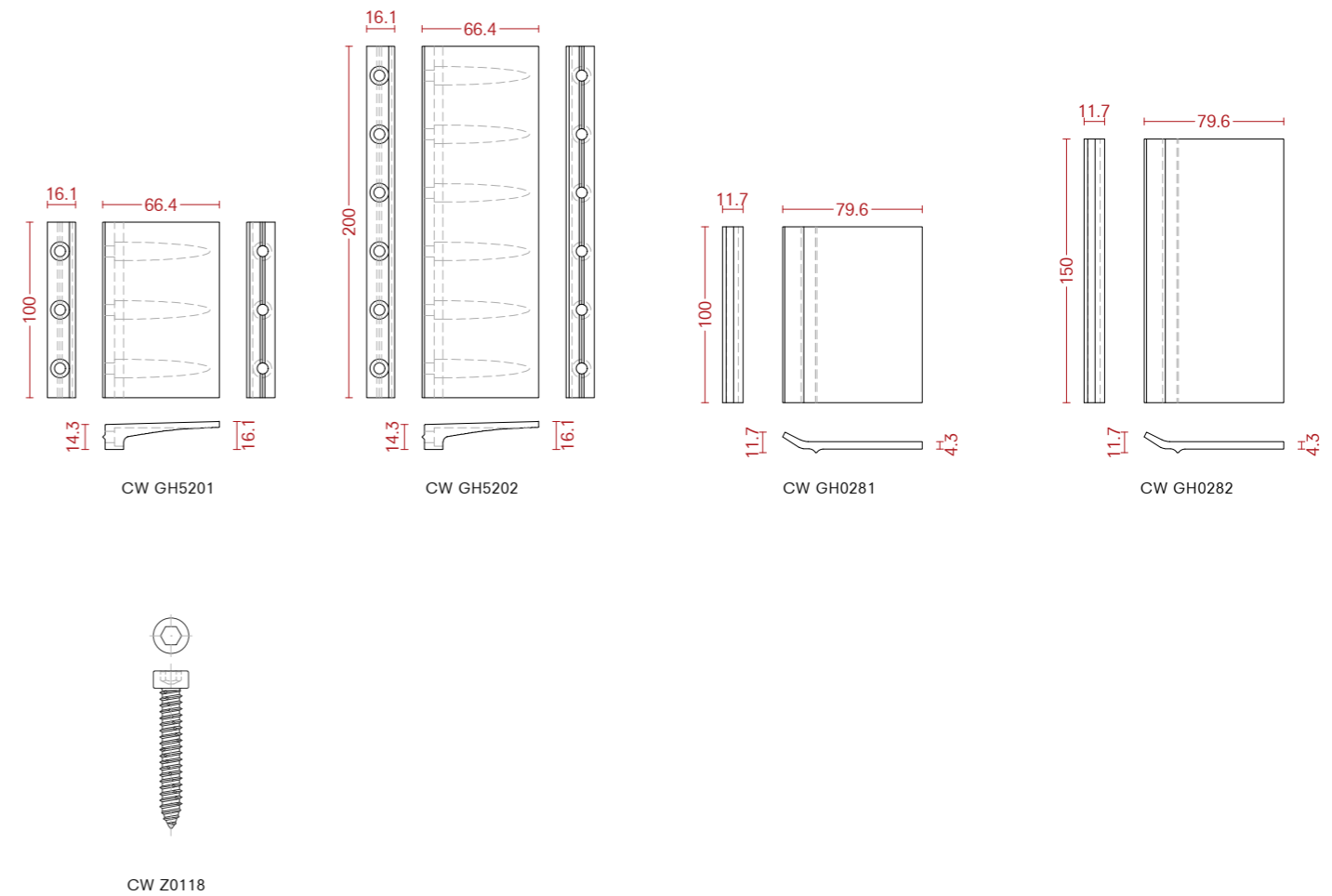

Curtain Walls CW50 TB

internal gaskets for mullions and transoms - flush - 2 levels - height 5 mm

EPDM

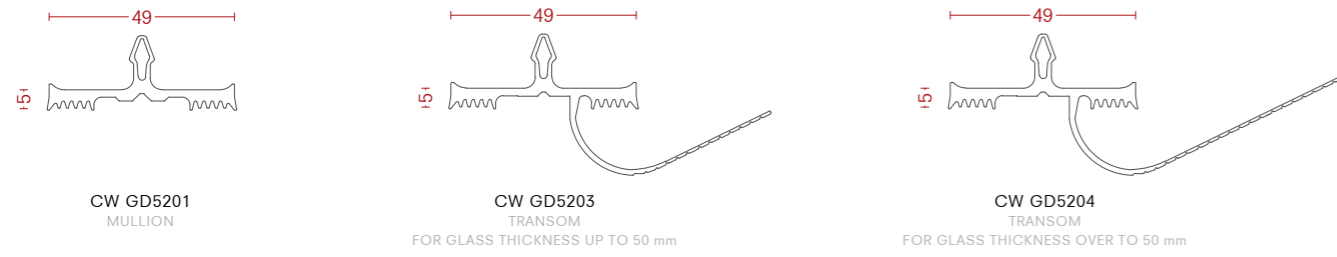

internal gaskets for mullions and transoms - overlapped - 3 levels - height 12 mm

EPDM

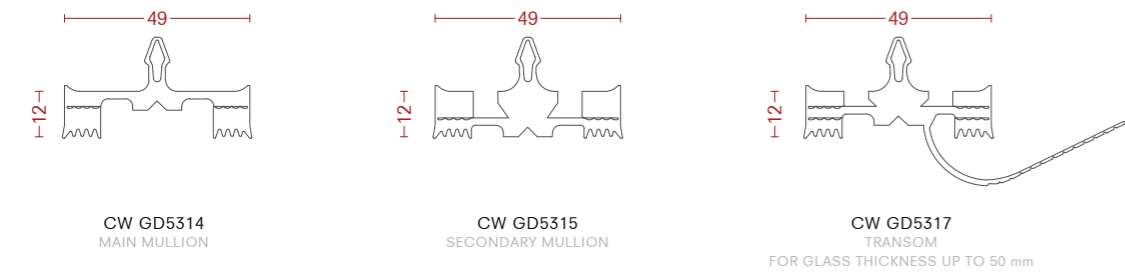

internal gaskets for mullions and transoms on roof (inclination roof system minimum of 2°) - height 10 mm

EPDM

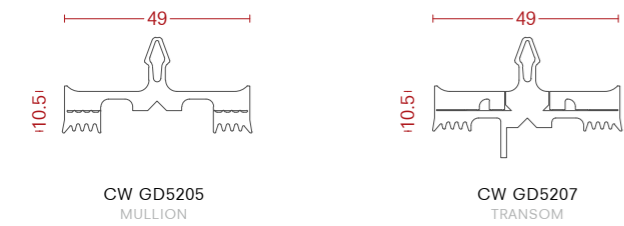

external gaskets for pressure plates

EPDM

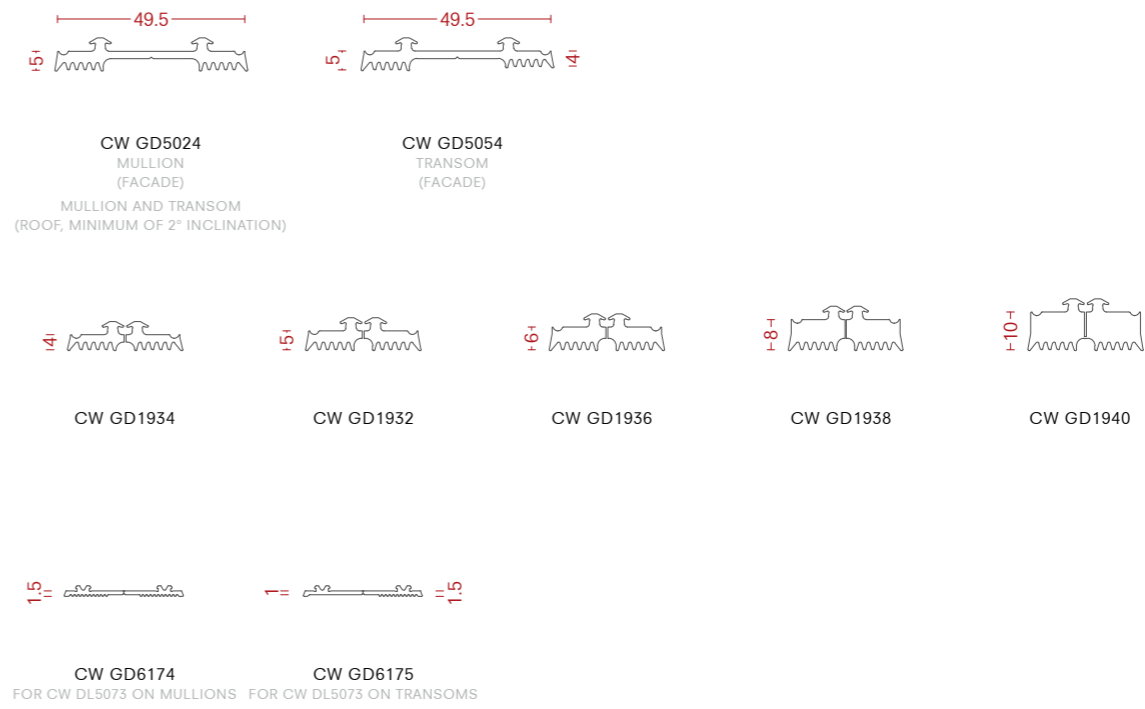

insulating strips expanded gasket

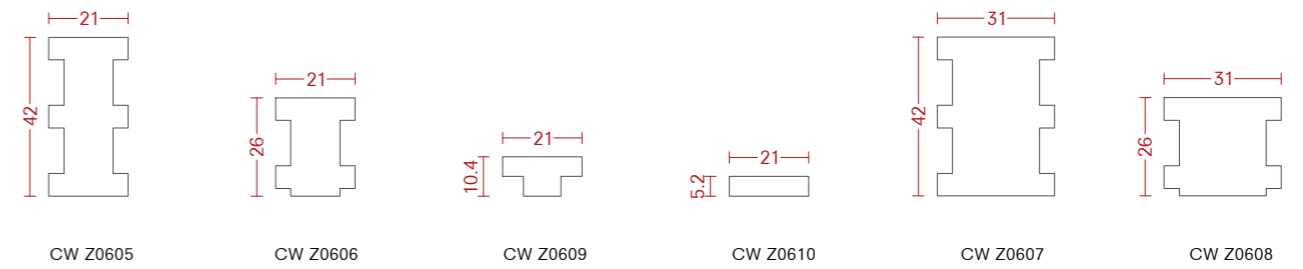

final field fill-in profiles

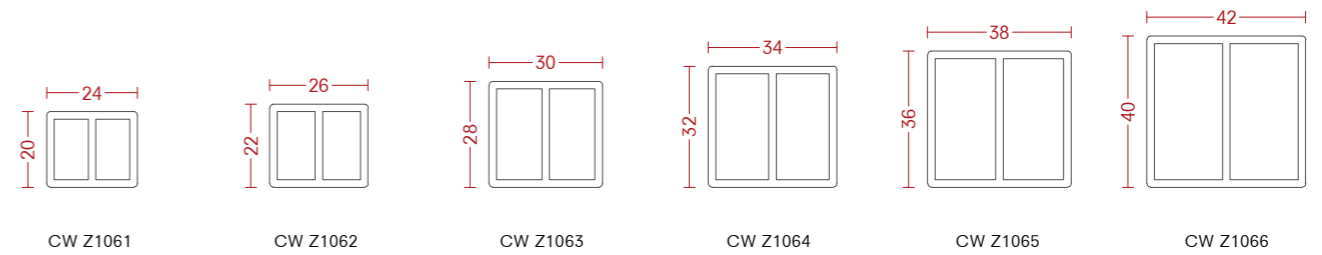

Curtain Walls CW50 TB

end caps for mullions and transoms

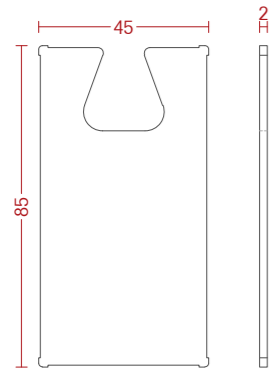

CW Z504X

Code	for
CW Z5045	CW SR5040-2
CW Z5046	CW SR5090-2
CW Z5047	CW SR50150-3

accessories and complementaries



CW Z0094
SEALANT FOR GASKETS

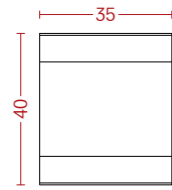

CW Z0501
STAINLESS STEEL
SEALING PLATES

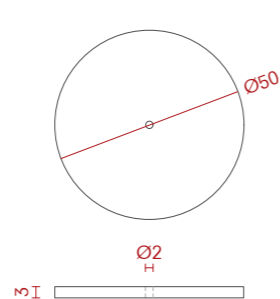

CW GD5009
PUNCTUAL PRESSURE PLATES

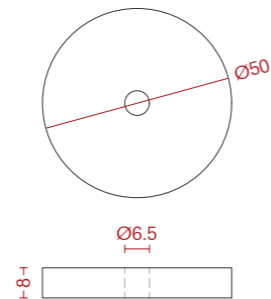

CW Z0020
PUNCTUAL PRESSURE PLATES

screws

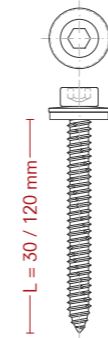

CW Z01XX
SELF TAPPING SCREW
STAINLESS STEEL

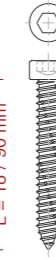

CW Z02XX
SELF TAPPING SCREW
STAINLESS STEEL

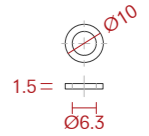

CW Z033
WASHER

Code	
CW Z0148	Ø6.3x30 mm
CW Z0149	Ø6.3x35 mm
CW Z0151	Ø6.3x40 mm
CW Z0152	Ø6.3x45 mm
CW Z0153	Ø6.3x50 mm
CW Z0154	Ø6.3x55 mm
CW Z0155	Ø6.3x60 mm
CW Z0156	Ø6.3x65 mm
CW Z0157	Ø6.3x70 mm
CW Z0158	Ø6.3x75 mm
CW Z0161	Ø6.3x80 mm
CW Z0162	Ø6.3x85 mm
CW Z0163	Ø6.3x90 mm
CW Z0164	Ø6.3x100 mm
CW Z0165	Ø6.3x105 mm
CW Z0167	Ø6.3x110 mm
CW Z0166	Ø6.3x120 mm

Code	
CW Z0293	Ø6.3x18 mm
CW Z0247	Ø6.3x25 mm
CW Z0253	Ø6.3x50 mm
CW Z0255	Ø6.3x60 mm
CW Z0257	Ø6.3x70 mm
CW Z0258	Ø6.3x75 mm
CW Z0241	Ø6.3x80 mm
CW Z0242	Ø6.3x85 mm
CW Z0243	Ø6.3x90 mm

external gaskets for burglar

EPDM

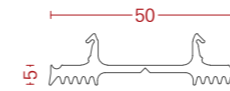

CW GD5122-WK
BURGLAR RESISTANCE
WITH CW UL5110

accessories for burglar

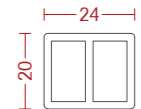

CW Z1061



CW Z0093

Curtain Walls CW60 TB

mullions and transoms with screwing groove

Galvanized steel

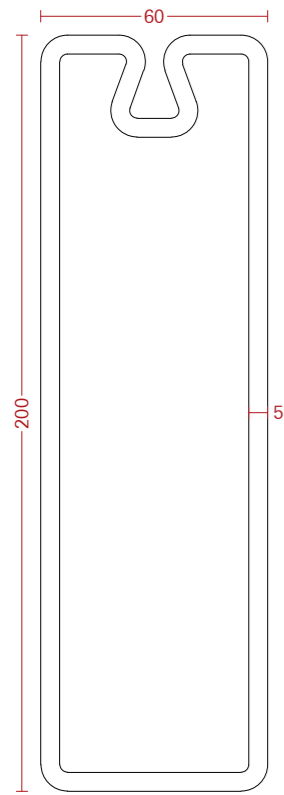

CW SR60200-5-10000

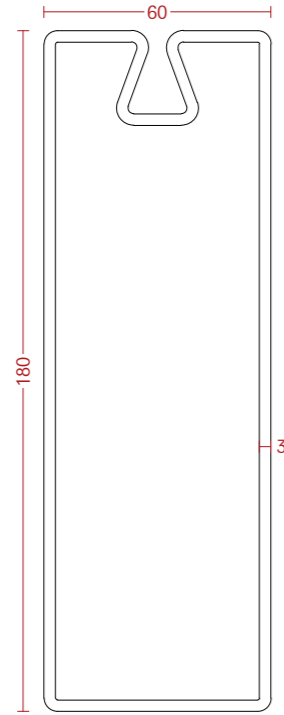

CW SR60180-3-9000

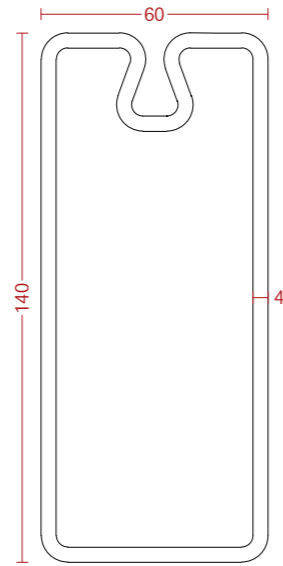

CW SR60140-4-8000

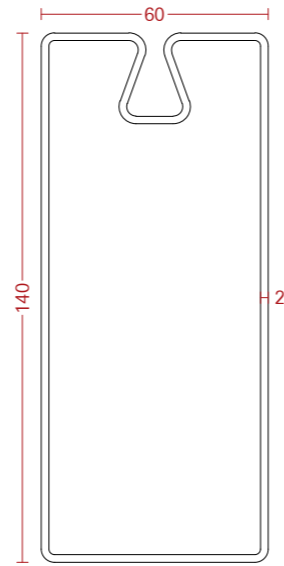

CW SR60140-2-6000
CW SR60140-2-10000

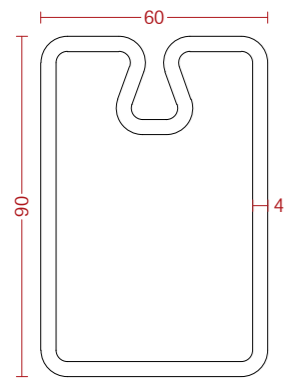

CW SR6090-4-8000

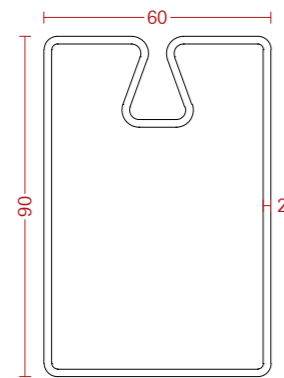

CW SR6090-2-6000
CW SR6090-2-10000

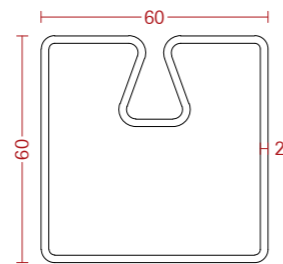

CW SR6060-2-6000

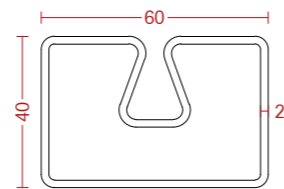

CW SR6040-2-6000

mullions and transoms with screwing groove

Galvanized steel

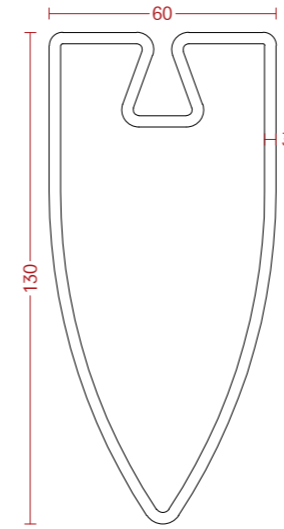

CW SR60130-3-D-8000

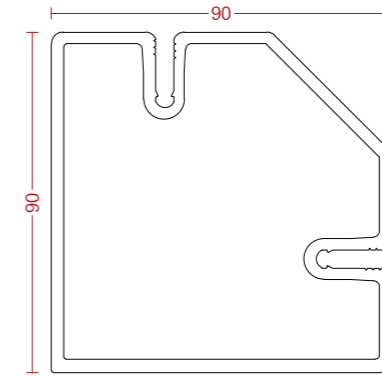

CW AL9090
ALUMINUM

snap-on cover caps

Aluminum

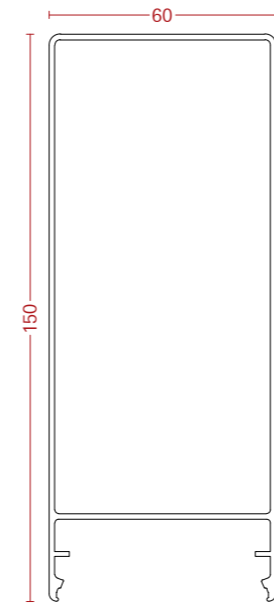

CW OL6081

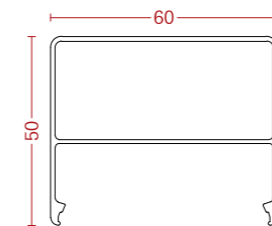

CW OL6015



CW OL6014

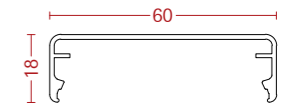

CW OL6013

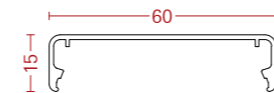

CW OL6012

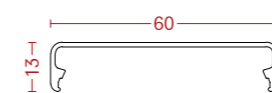

CW OL6011

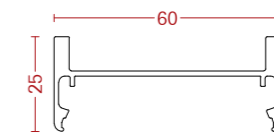

CW OL6016

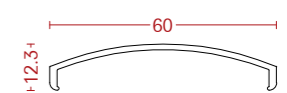

CW OL6066

Curtain Walls CW60 TB

snap-on cover caps

Stainless steel

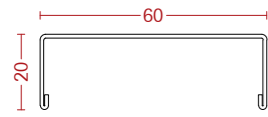

CW OL6064
STAINLESS STEEL

pressure plates

Aluminum

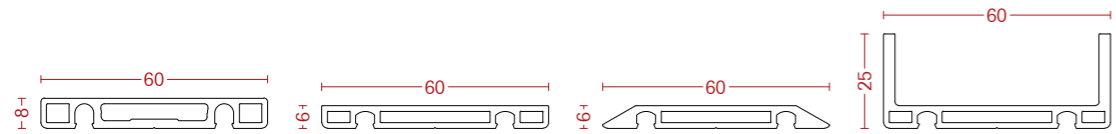

CW DL6059

CW DL6071

CW DL6067

CW DL6061

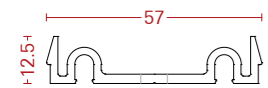

CW UL6007-L
FOR CW OL6064

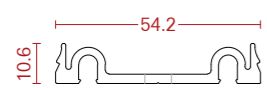

CW UL6009
CW UL6009-L

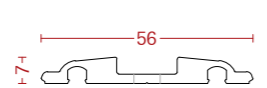

CW UL6005-L

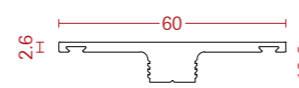

CW DL6073

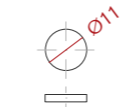

CW Z0089
COVER PLUG
FOR CW DL6073

pressure plates

Stainless steel

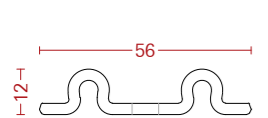

CW UL6110C
GALVANIZED STEEL

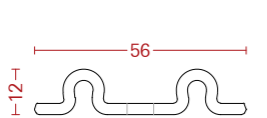

CW UL6110
FOR BURGLAR RESISTANCE

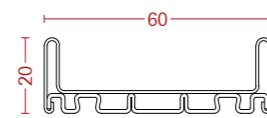

CW DL6044



CW DL6018

transom connectors and adapter profiles

Aluminum

CW RHT60XXX-n

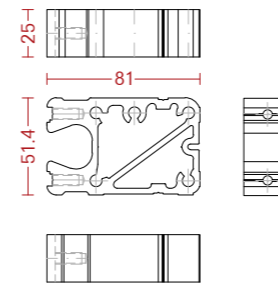

Code	for
CW RHT6040-2	CW SR6040-2
CW RHT6060-2	CW SR6060-2
CW RHT6090-2	CW SR6090-2
CW RHT6090-4	CW SR6090-4
CW RHT60140-2	CW SR60140-2
CW RHT60140-4	CW SR60140-4
CW RHT60180-3	CW SR60180-3

CW RHT60XXX-n-XXXX WITHOUT HOLES

Code	for
CW RHT6090-2-6000	CW SR6090-2
CW RHT6090-4-6000	CW SR6090-4
CW RHT60140-2-6000	CW SR60140-2
CW RHT60140-4-6000	CW SR60140-4
CW RHT60180-3-6000	CW SR60180-3

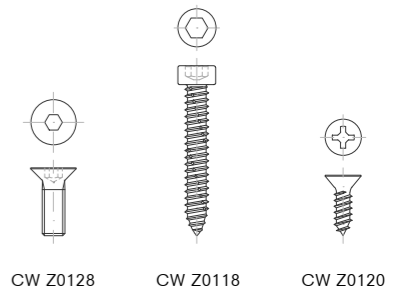

CW Z0128

CW Z0118

CW Z0120

glass supports

Aluminum

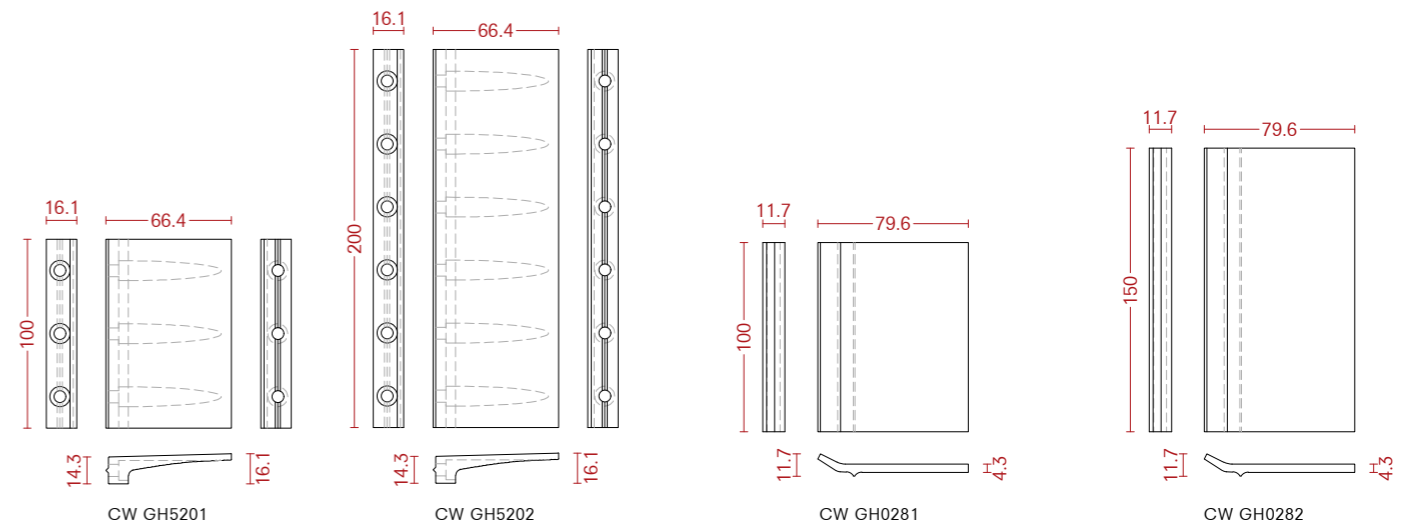

CW GH5201

CW GH5202

CW GH0281

CW GH0282

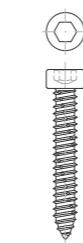

CW Z0118

Curtain Walls CW60 TB

internal gaskets for mullions and transoms - flush - 2 levels - height 5 mm

EPDM

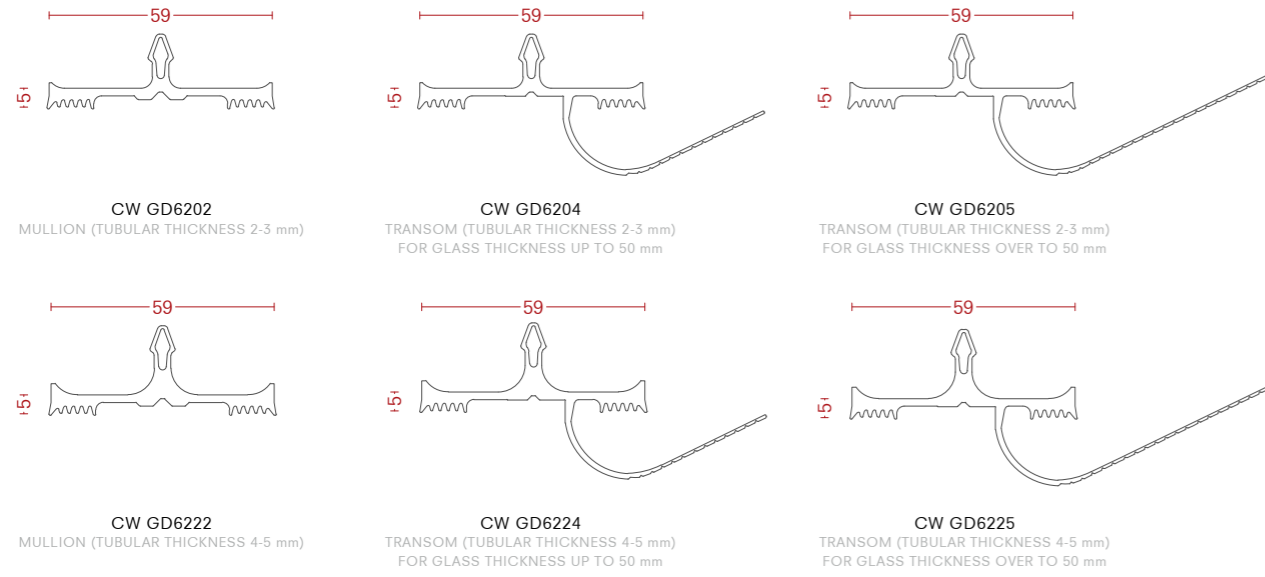

internal gaskets for mullions and transoms - overlapping - 2 levels - height 10 mm

EPDM

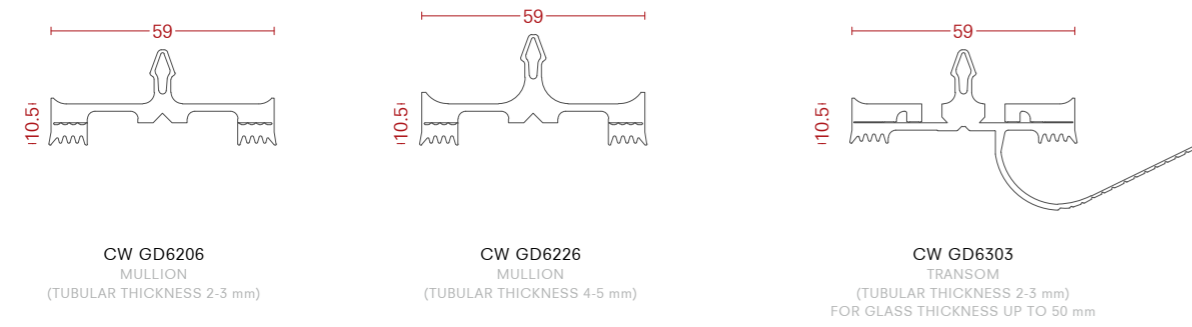

internal gaskets for mullions and transoms - overlapping - 3 levels - height 12 mm

EPDM

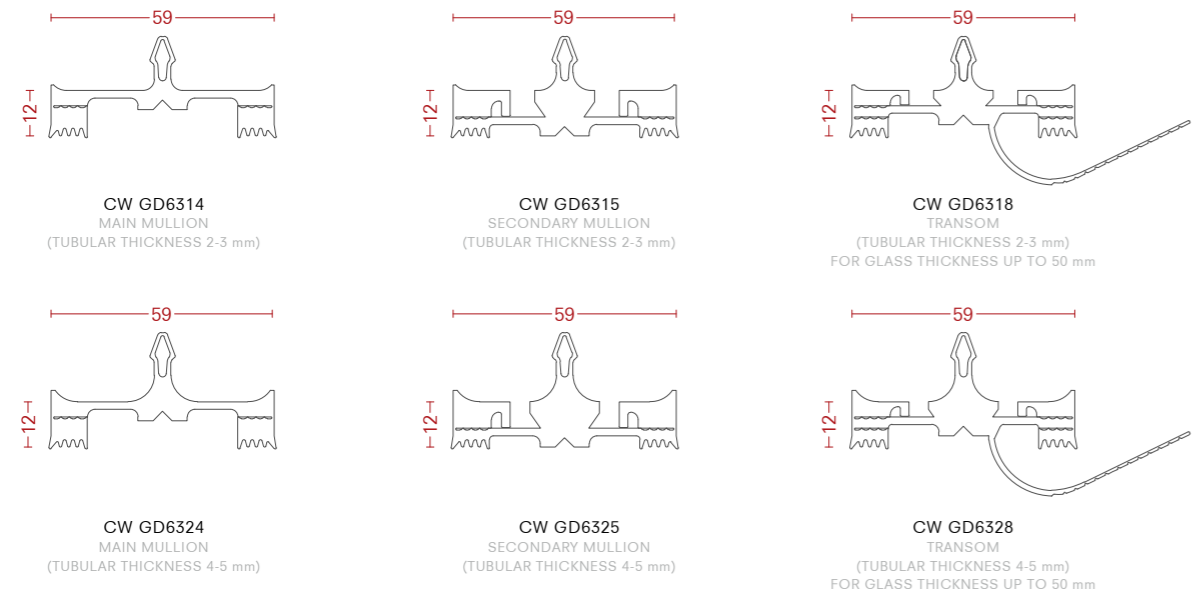

internal gaskets for mullions - polygonal facade - in combination with gaskets for pressure plates CW GD1925 and CW GD1928

EPDM

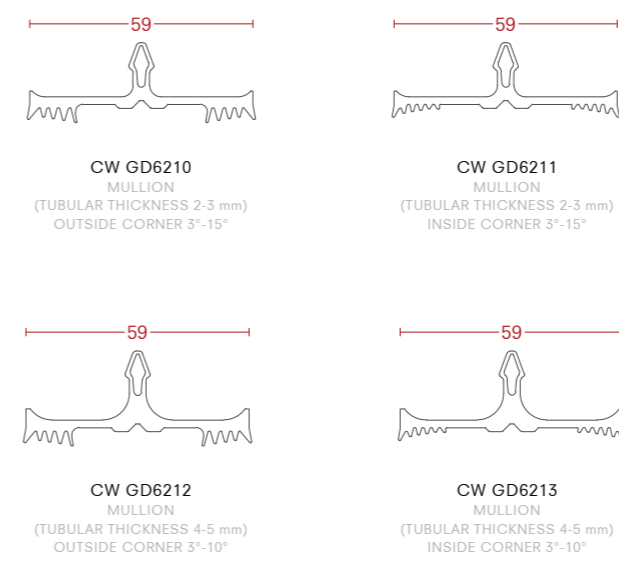

internal gaskets for mullions and transoms for roof (inclination roof system minimum of 2°) - height 10 mm

EPDM

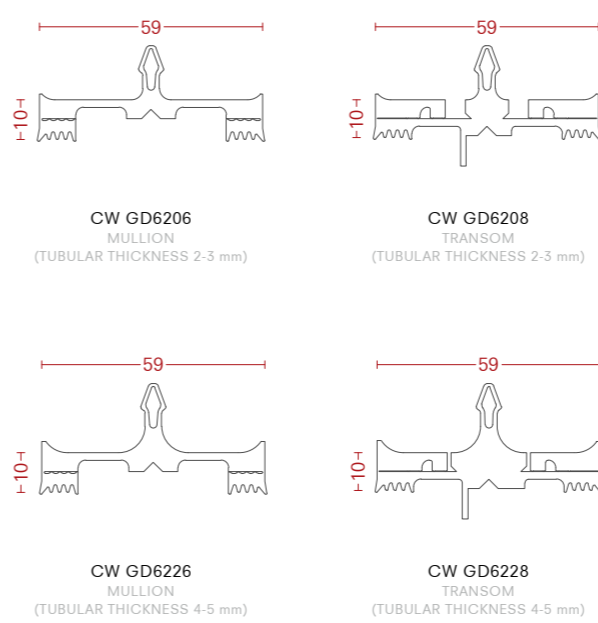

internal gaskets for mullions and transoms for roof (inclination roof system minimum of 2°) - height 14 mm

EPDM

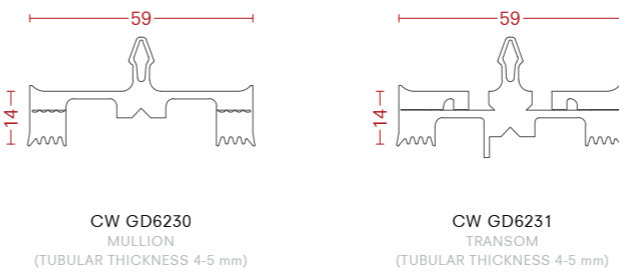

Curtain Walls CW60 TB

external gaskets for pressure plates

EPDM



CW GD6024
MULLION
(FACADE)
MULLION AND TRANSOM
(ROOF, MINIMUM OF 2° INCLINATION)



CW GD6054
TRANSOM
(FACADE)



CW GD6940
FOR CW DL6018 ON MULLIONS
AND TRANSOMS



CW GD1934



CW GD1932



CW GD1936



CW GD1938



CW GD1940



CW GD1925
OUTSIDE CORNER
INCLINATION 3°-15°

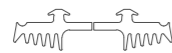

CW GD1928
INSIDE CORNER
INCLINATION 3°-10°



CW GD6174
FOR CW DL6073
ON MULLIONS



CW GD6175
FOR CW DL6073
ON TRANSOMS

end caps for mullions and transoms

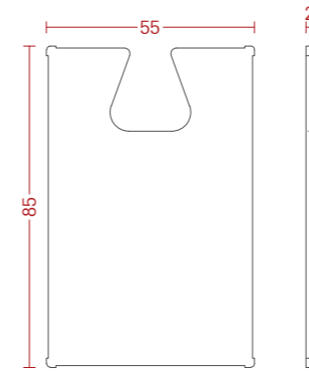

CW Z6XXX

Code	for
CW Z6046	CW SR6040-2
CW Z6101	CW SR6090-2
CW Z6047	CW SR6090-2
CW Z6050	CW SR6090-4
CW Z6048	CW SR60140-2
CW Z6051	CW SR60140-4
CW Z6056	CW SR60180-3

insulating strips expanded gasket

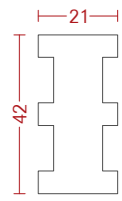

CW Z0605

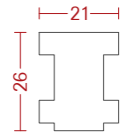

CW Z0606



CW Z0609

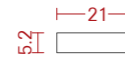

CW Z0610

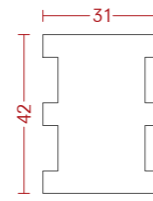

CW Z0607

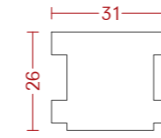

CW Z0608

accessories and complementaries



CW Z0094
SEALANT FOR GASKETS

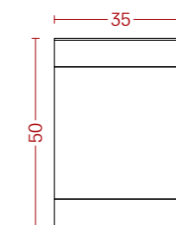

CW Z0601
STAINLESS STEEL
SEALING PLATES

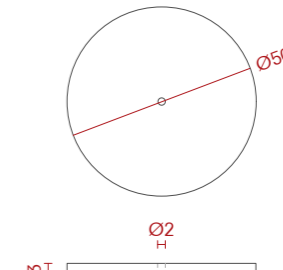

CW GD5009
PUNCTUAL PRESSURE PLATES

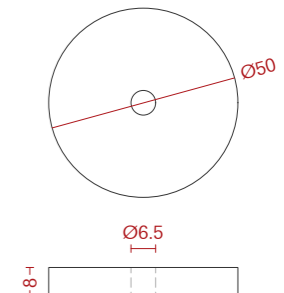

CW Z0020
PUNCTUAL PRESSURE PLATE

final field fill-in profiles

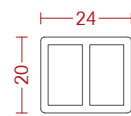

CW Z1061

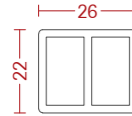

CW Z1062

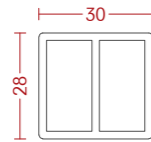

CW Z1063

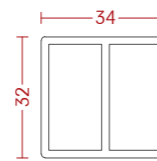

CW Z1064

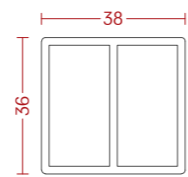

CW Z1065

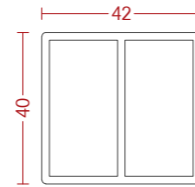

CW Z1066

Curtain Walls CW60 TB

screws

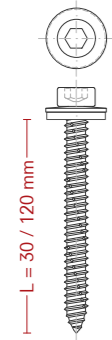

CW Z01XX
SELF TAPPING SCREW
STAINLESS STEEL

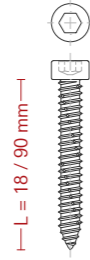

CW Z02XX
SELF TAPPING SCREW
STAINLESS STEEL

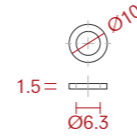

CW Z033
WASHER

Code	Dimensions
CW Z0148	Ø6.3x30 mm
CW Z0149	Ø6.3x35 mm
CW Z0151	Ø6.3x40 mm
CW Z0152	Ø6.3x45 mm
CW Z0153	Ø6.3x50 mm
CW Z0154	Ø6.3x55 mm
CW Z0155	Ø6.3x60 mm
CW Z0156	Ø6.3x65 mm
CW Z0157	Ø6.3x70 mm
CW Z0158	Ø6.3x75 mm
CW Z0161	Ø6.3x80 mm
CW Z0162	Ø6.3x85 mm
CW Z0163	Ø6.3x90 mm
CW Z0164	Ø6.3x100 mm
CW Z0165	Ø6.3x105 mm
CW Z0167	Ø6.3x110 mm
CW Z0166	Ø6.3x120 mm

Code	Dimensions
CW Z0293	Ø6.3x18 mm
CW Z0247	Ø6.3x25 mm
CW Z0253	Ø6.3x50 mm
CW Z0255	Ø6.3x60 mm
CW Z0257	Ø6.3x70 mm
CW Z0258	Ø6.3x75 mm
CW Z0241	Ø6.3x80 mm
CW Z0242	Ø6.3x85 mm
CW Z0243	Ø6.3x90 mm

external gaskets for burglar

EPDM

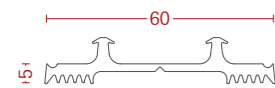

CW GD6122-WK
BURGLAR RESISTANCE
WITH CW UL6110, CW UL6110C

accessories for burglar resistance

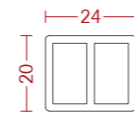

CW Z1061



CW Z0093



Curtain walls CW50-1 TB

fixing channel

Aluminum

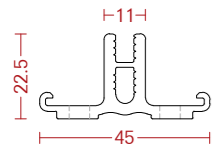

CW AK5010

examples of laser welded custom profiles

- 14 Laser welded and sand blasted steel
- 33 Laser welded and sand blasted stainless steel AISI 304L
- 34 Laser welded and sand blasted stainless steel AISI 316L

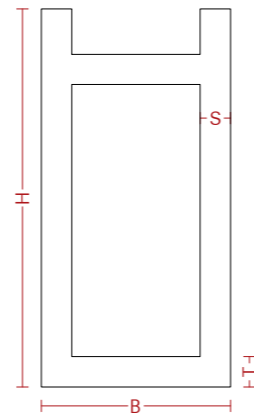
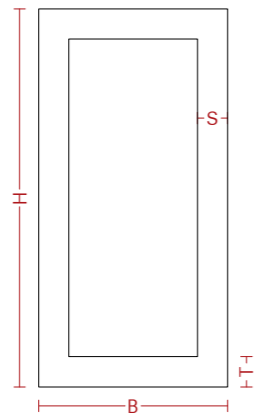
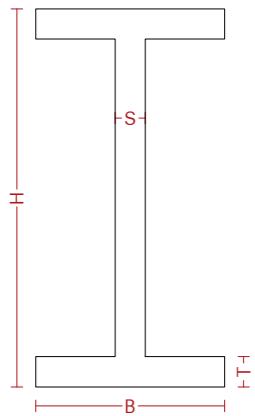
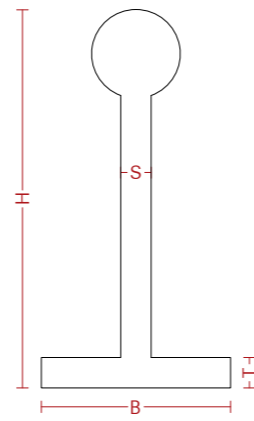
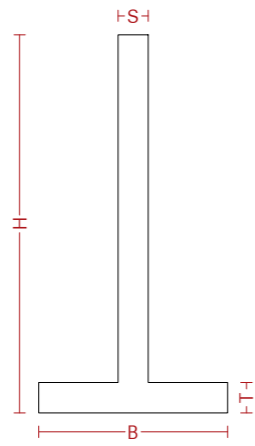
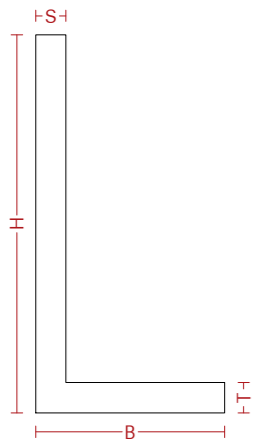

SIZE RANGE

B min	B max	H min	H max	S min	S max	T min	T max	L max
50	400	40	1000	4	30	4	50	15000

snap-on cover caps

Aluminum

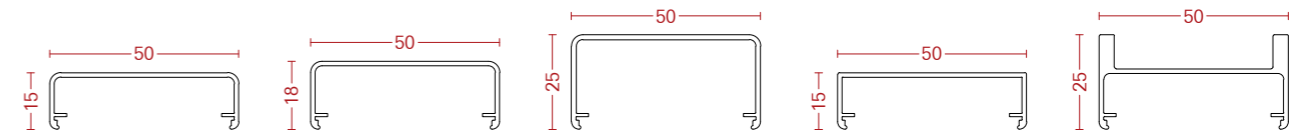

CW OL5012

CW OL5013

CW OL5014

CW OL5025

CW OL5016

pressure plates

Aluminum



CW UL5009
CW UL5009L

CW UL5110
STAINLESS STEEL
FOR BURGLAR

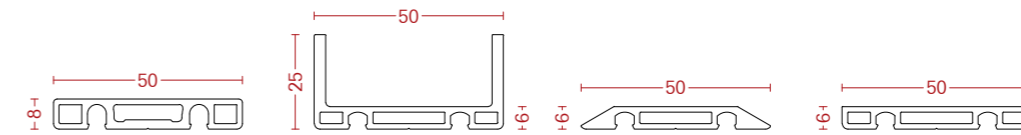

CW DL5059

CW DL5061

CW DL5067

CW DL5071

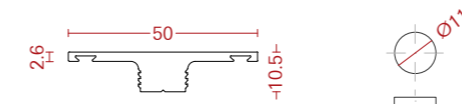

CW DL5073

CW Z0089
COVER PLUG
FOR CW DL5073

Curtain walls CW50-1 TB

glass supports

Aluminum

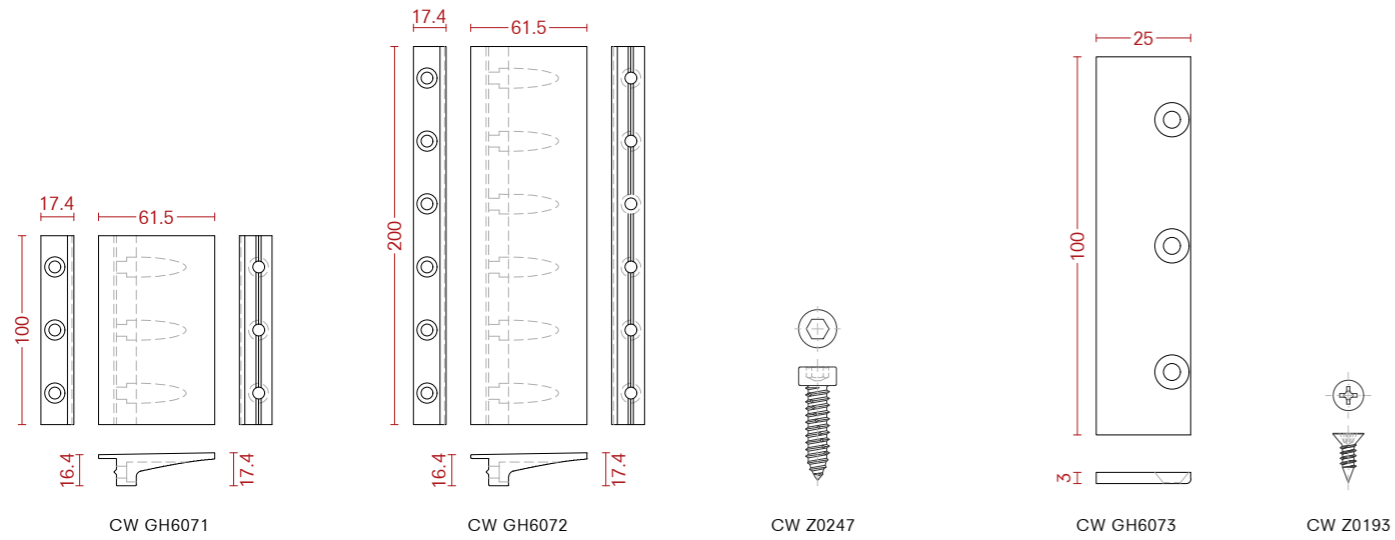

insulating strips expanded gasket

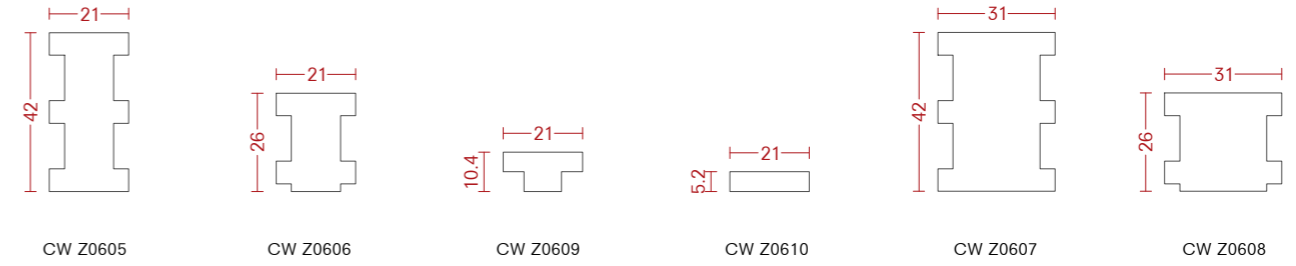

internal gaskets for mullions and transoms - overlapping - 2 levels - height 16.5 mm

EPDM

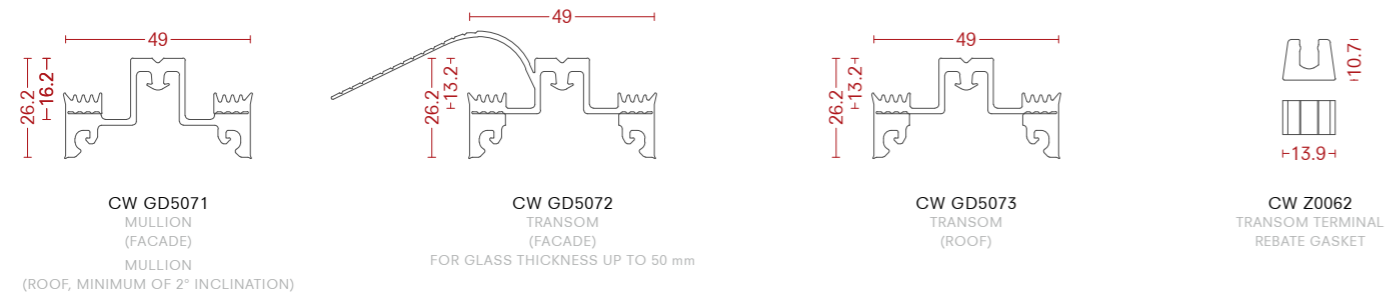

final field fill-in profiles

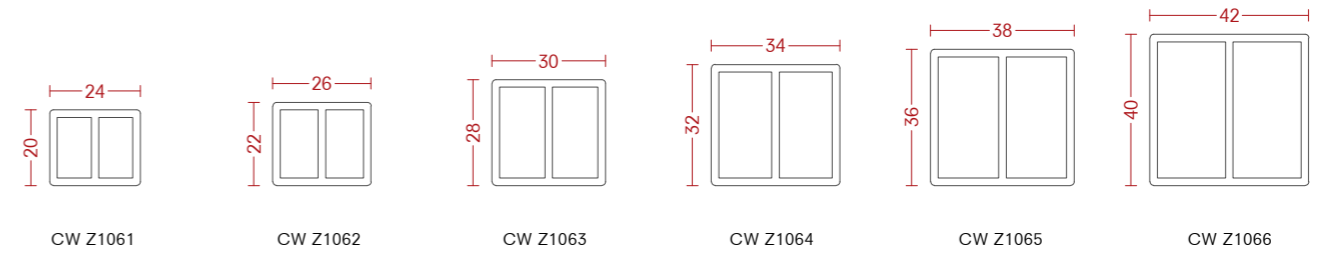

external gaskets for pressure plates

EPDM

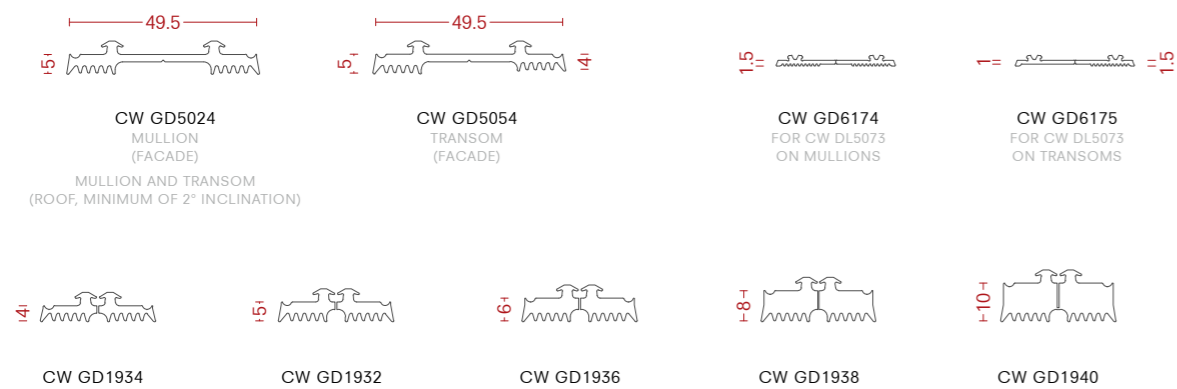

accessories and complementaries

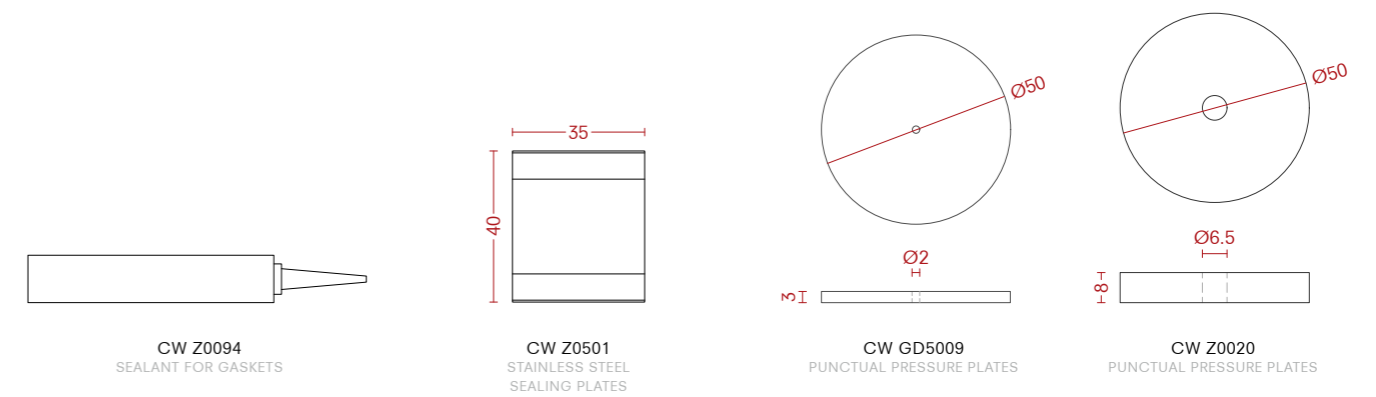

Curtain walls CW50-1 TB

screws

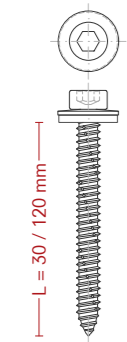
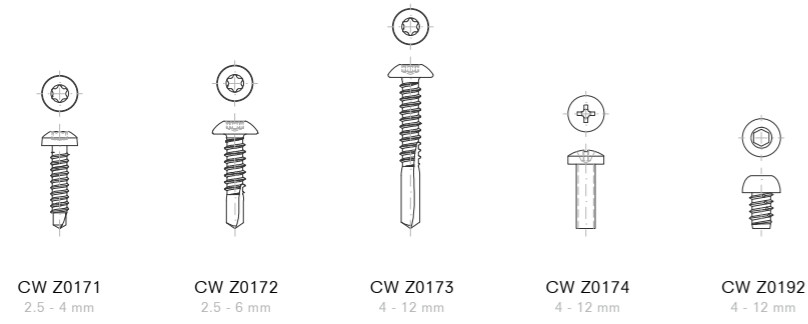

CW Z01XX
SELF TAPPING SCREW
STAINLESS STEEL

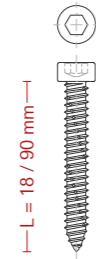

CW Z02XX
SELF TAPPING SCREW
STAINLESS STEEL

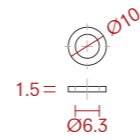

CW Z033
WASHER

Code	Dimensions
CW Z0148	Ø6.3x30 mm
CW Z0149	Ø6.3x35 mm
CW Z0151	Ø6.3x40 mm
CW Z0152	Ø6.3x45 mm
CW Z0153	Ø6.3x50 mm
CW Z0154	Ø6.3x55 mm
CW Z0155	Ø6.3x60 mm
CW Z0156	Ø6.3x65 mm
CW Z0157	Ø6.3x70 mm
CW Z0158	Ø6.3x75 mm
CW Z0161	Ø6.3x80 mm
CW Z0162	Ø6.3x85 mm
CW Z0163	Ø6.3x90 mm
CW Z0164	Ø6.3x100 mm
CW Z0165	Ø6.3x105 mm
CW Z0167	Ø6.3x110 mm
CW Z0166	Ø6.3x120 mm

Code	Dimensions
CW Z0293	Ø6.3x18 mm
CW Z0247	Ø6.3x25 mm
CW Z0253	Ø6.3x50 mm
CW Z0255	Ø6.3x60 mm
CW Z0257	Ø6.3x70 mm
CW Z0258	Ø6.3x75 mm
CW Z0241	Ø6.3x80 mm
CW Z0242	Ø6.3x85 mm
CW Z0243	Ø6.3x90 mm

external gaskets for burglar

EPDM

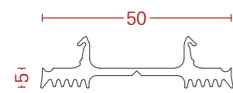

CW GD5122-WK
BURGLAR RESISTANCE
WITH CW UL5110

accessories for burglar

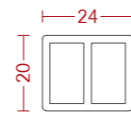

CW Z1061



CW Z0093

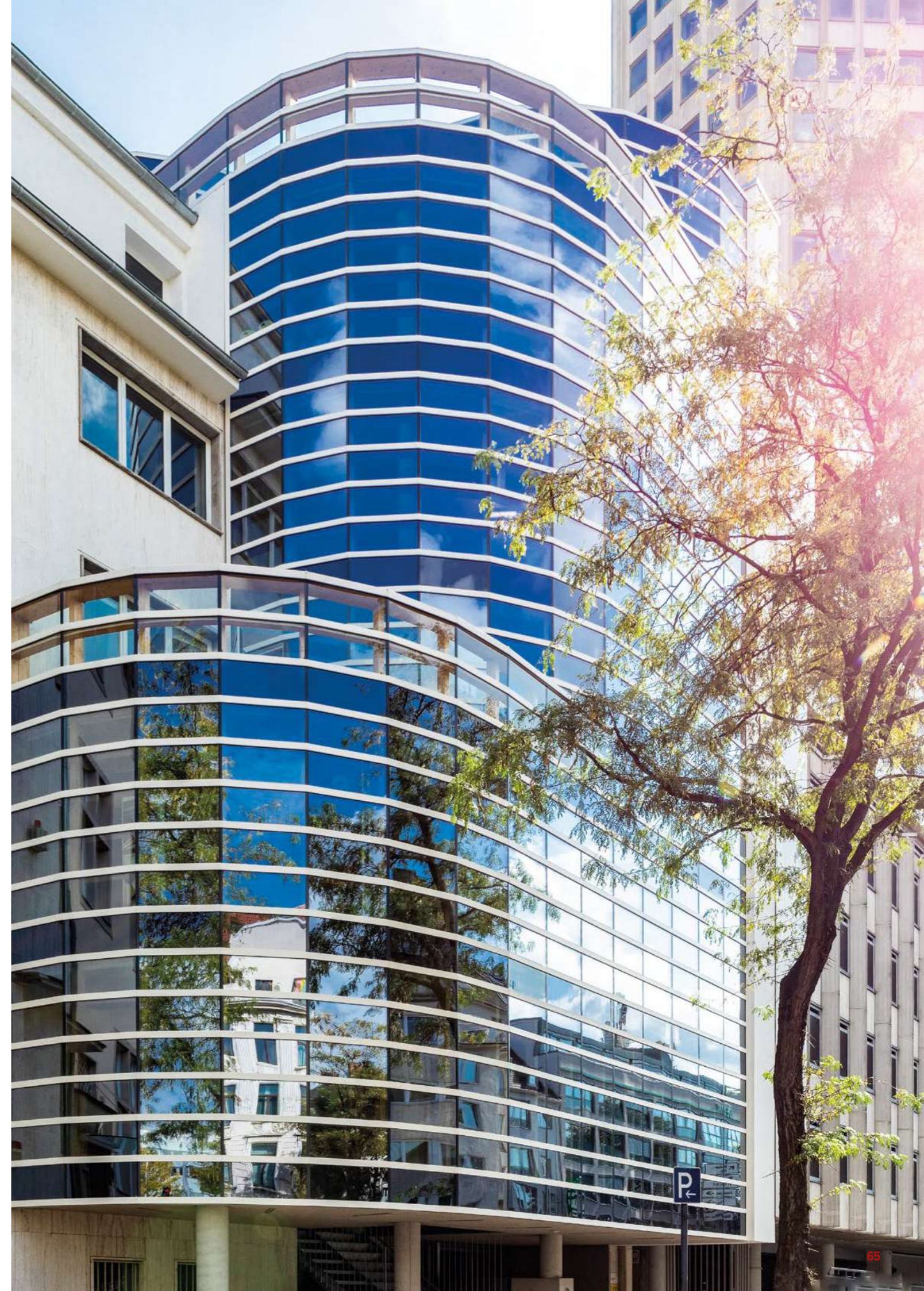

Curtain walls CW60-1 TB

fixing channel

Aluminum

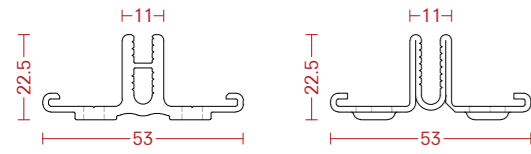

CW AK6010

CW AK6020
GALVANIZED STEEL
CW AK6020S
RAW STEEL

examples of laser welded custom profiles

- 14 Laser welded and sand blasted steel
- 33 Laser welded and sand blasted stainless steel AISI 304L
- 34 Laser welded and sand blasted stainless steel AISI 316L

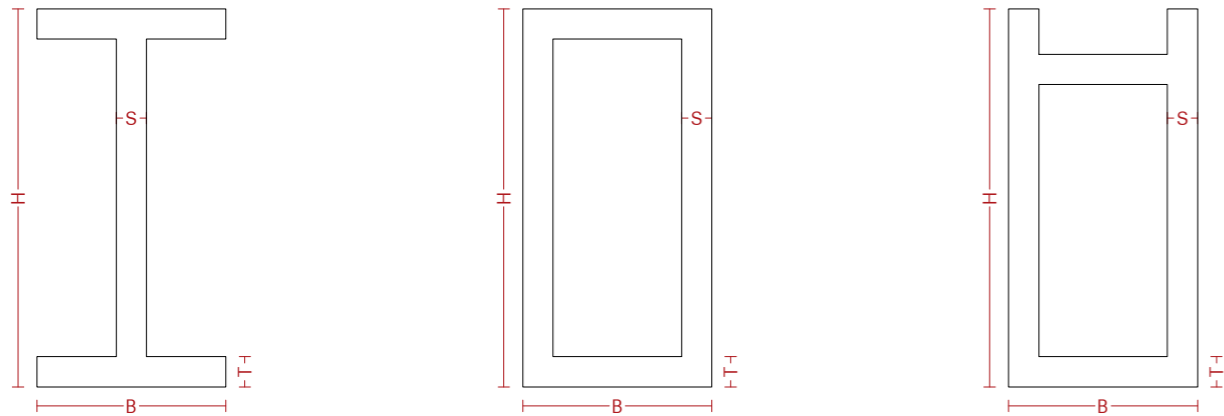
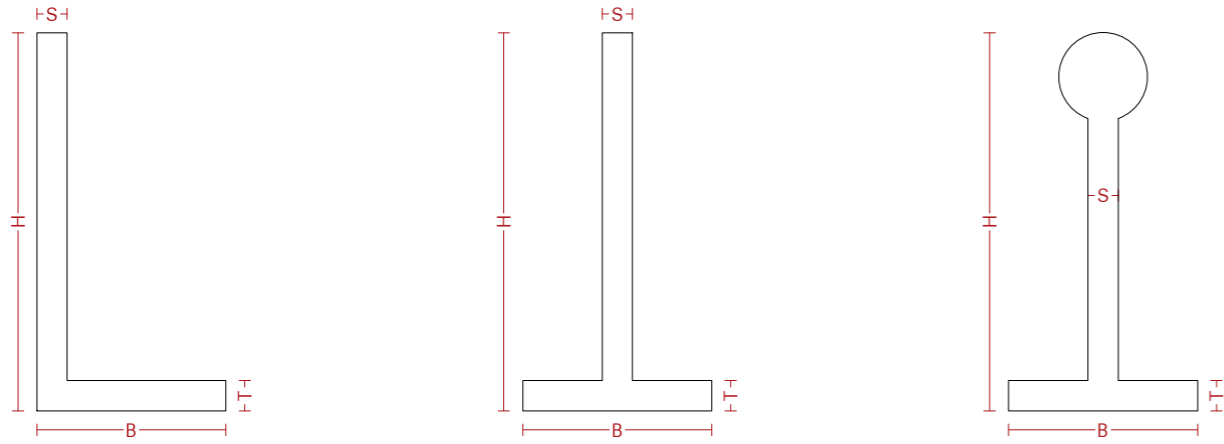

SIZE RANGE

B min	B max	H min	H max	S min	S max	T min	T max	L max
50	400	40	1000	4	30	4	50	15000

snap-on cover caps

Aluminum

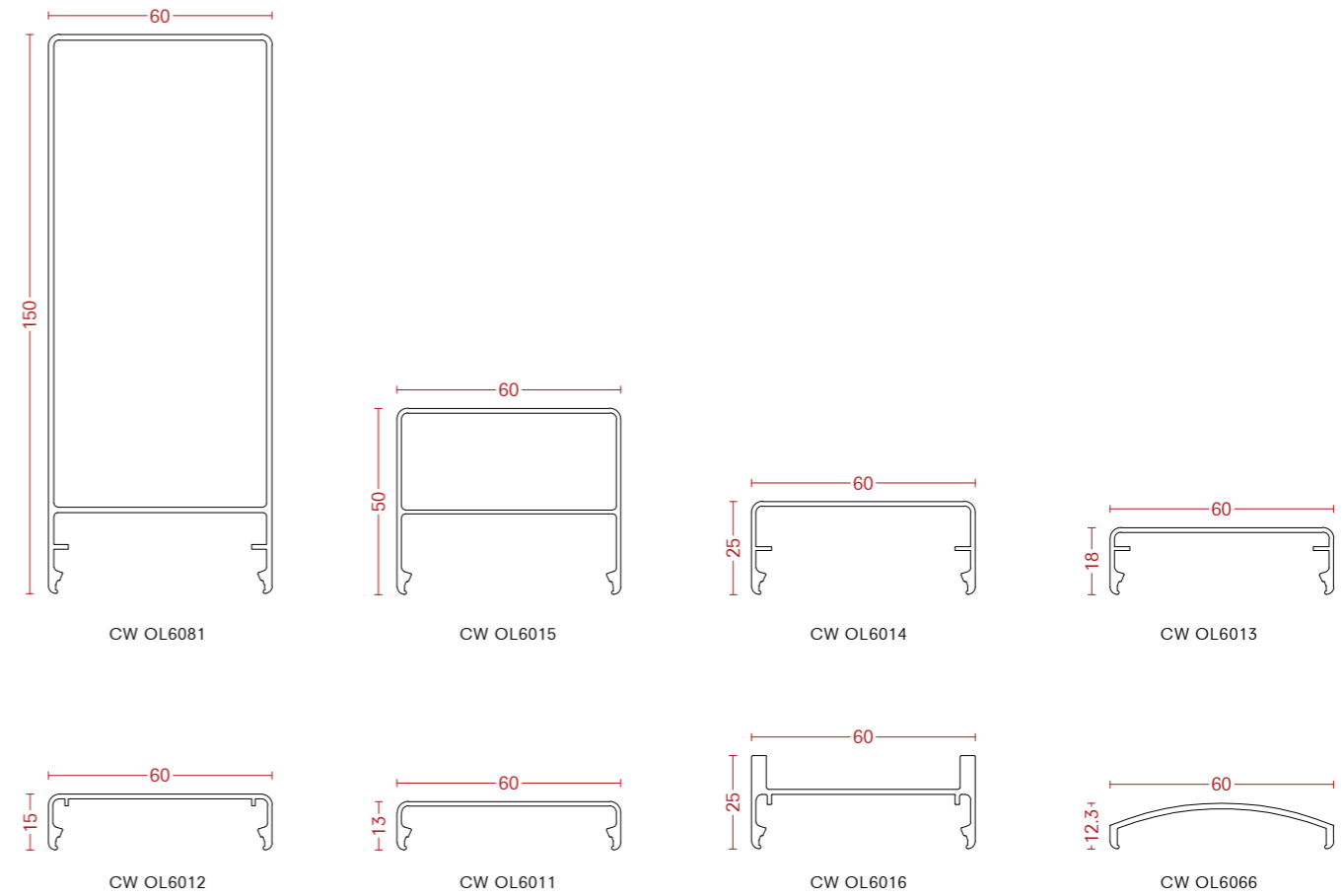

snap-on cover caps

Stainless steel

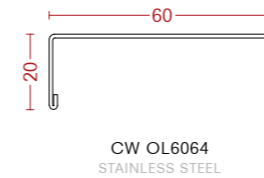

Curtain walls CW60-1 TB

pressure plates

Aluminum

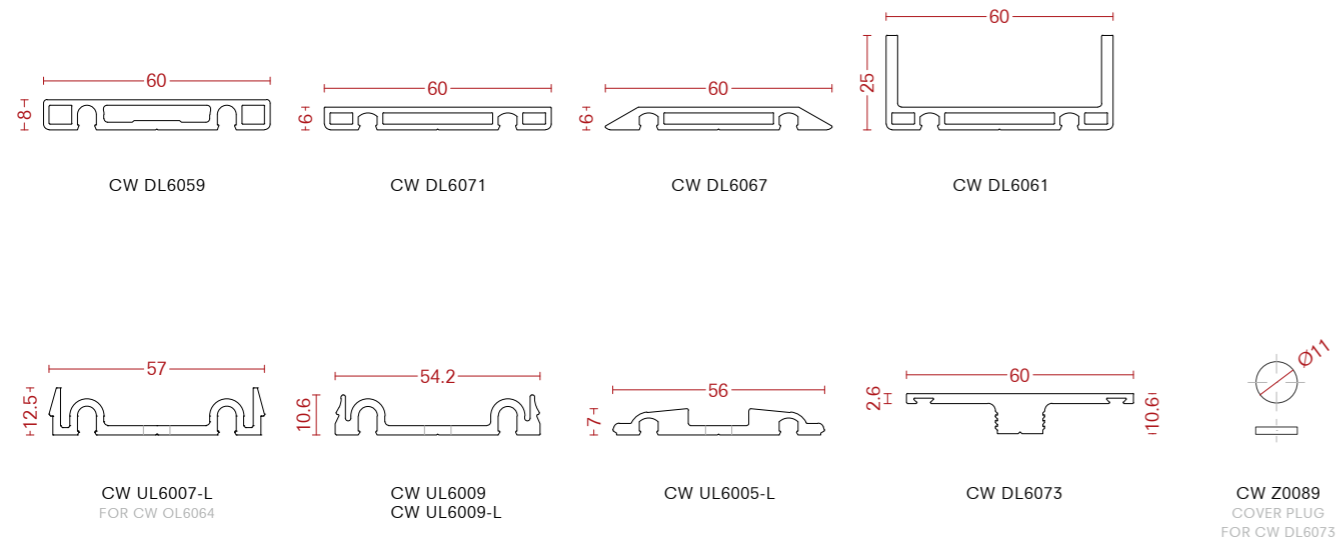

glass supports

Aluminum

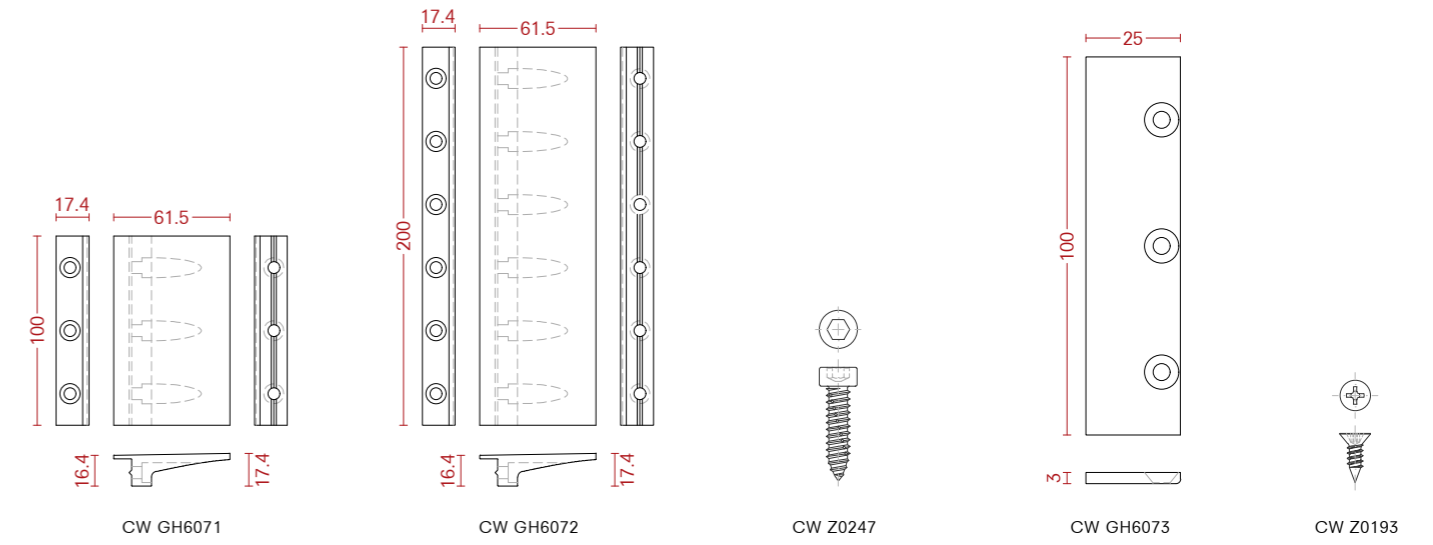

pressure plates

Stainless steel

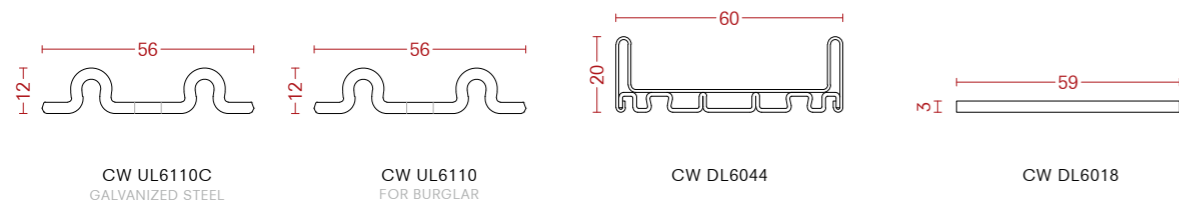

internal gaskets for mullions and transoms - overlapping - 2 levels - height 16.5 mm

EPDM

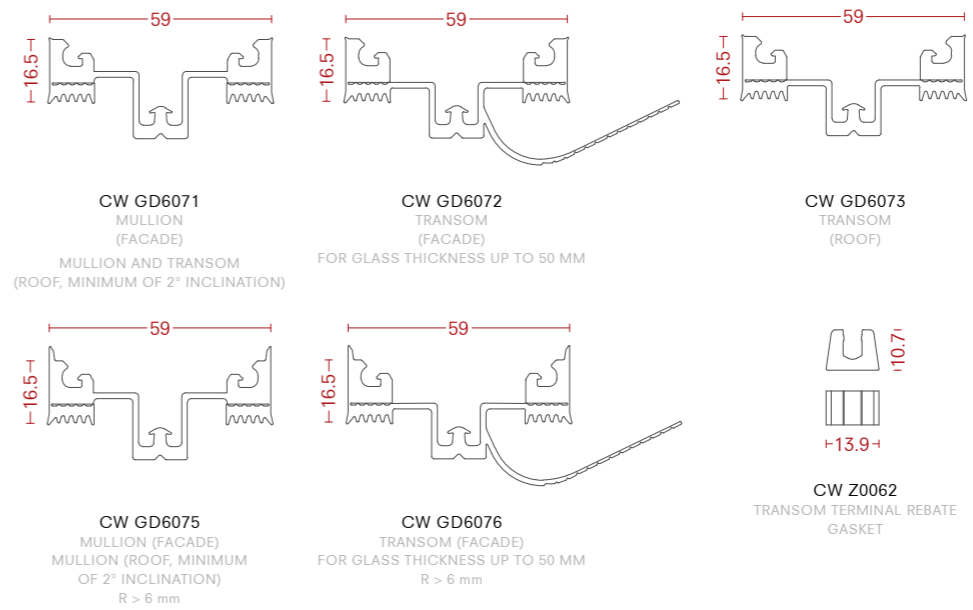

internal gaskets for mullions and transoms for roof (inclination roof system minimum of 2°) - height 22.5 mm

EPDM

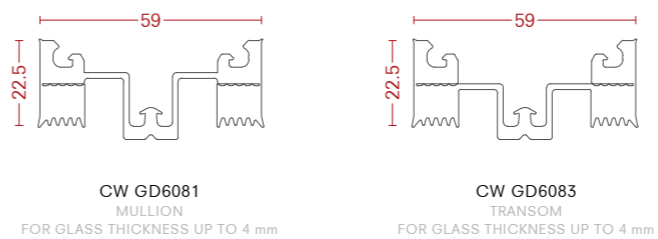

Curtain walls CW60-1 TB

internal gaskets for mullions - polygonal facade - in combination with gasket for pressure plate CW GD1925

EPDM

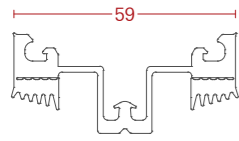

CW GD6074
MULLION (FACADE)
OUTSIDE CORNER 3°-15°

external gaskets for pressure plates

EPDM

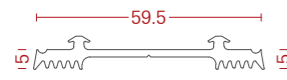

CW GD6024
MULLION (FACADE)

MULLION AND TRANSOM
(ROOF, MINIMUM OF 2° INCLINATION)



CW GD6054
TRANSOM (FACADE)

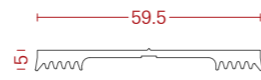

CW GD6940
FOR CW DL6018 ON MULLIONS
AND TRANSOMS



CW GD1934



CW GD1932



CW GD1936



CW GD1938



CW GD1940



CW GD1925
OUTSIDE CORNER 3°-15°



CW GD1928
INSIDE CORNER 3°-10°

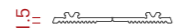

CW GD6174
FOR CW DL6073
ON MULLIONS



CW GD6175
FOR CW DL6073
ON TRANSOMS

insulating strips expanded gasket

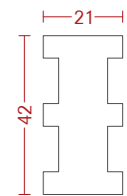

CW Z0605

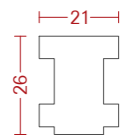

CW Z0606

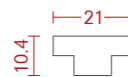

CW Z0609

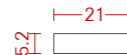

CW Z0610

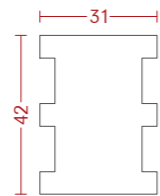

CW Z0607

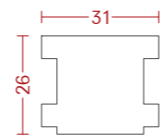

CW Z0608

final field fill-in profiles

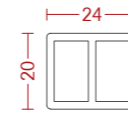

CW Z1061

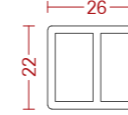

CW Z1062

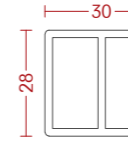

CW Z1063

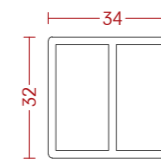

CW Z1064

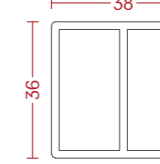

CW Z1065

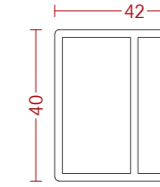

CW Z1066

accessories and complementaries



CW Z0094
SEALANT FOR GASKETS

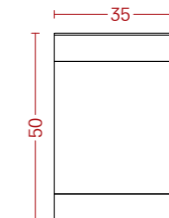

CW Z0601
STAINLESS STEEL
SEALING PLATES

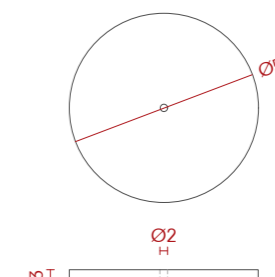

CW GD5009
PUNCTUAL PRESSURE PLATES

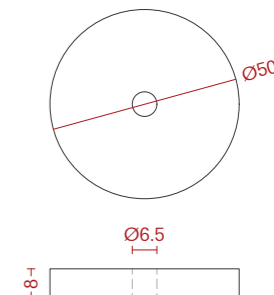

CW Z0020
PUNCTUAL PRESSURE PLATES

screws



CW Z0171



CW Z0172



CW Z0173



CW Z0174



CW Z0192

Curtain walls CW60-1 TB

screws

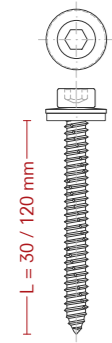

CW Z01XX
SELF TAPPING SCREW
STAINLESS STEEL

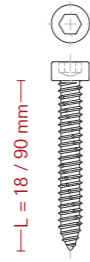

CW Z02XX
SELF TAPPING SCREW
STAINLESS STEEL

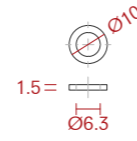

CW Z033
WASHER

Code	Dimensions
CW Z0148	Ø6.3x30 mm
CW Z0149	Ø6.3x35 mm
CW Z0151	Ø6.3x40 mm
CW Z0152	Ø6.3x45 mm
CW Z0153	Ø6.3x50 mm
CW Z0154	Ø6.3x55 mm
CW Z0155	Ø6.3x60 mm
CW Z0156	Ø6.3x65 mm
CW Z0157	Ø6.3x70 mm
CW Z0158	Ø6.3x75 mm
CW Z0161	Ø6.3x80 mm
CW Z0162	Ø6.3x85 mm
CW Z0163	Ø6.3x90 mm
CW Z0164	Ø6.3x100 mm
CW Z0165	Ø6.3x105 mm
CW Z0167	Ø6.3x110 mm
CW Z0166	Ø6.3x120 mm

Code	Dimensions
CW Z0293	Ø6.3x18 mm
CW Z0247	Ø6.3x25 mm
CW Z0253	Ø6.3x50 mm
CW Z0255	Ø6.3x60 mm
CW Z0257	Ø6.3x70 mm
CW Z0258	Ø6.3x75 mm
CW Z0241	Ø6.3x80 mm
CW Z0242	Ø6.3x85 mm
CW Z0243	Ø6.3x90 mm

external gaskets for burglar

EPDM

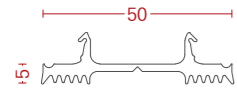

CW GD6122-WK
BURGLAR
WITH CW UL6110, CW UL6110C

accessories for burglar resistance

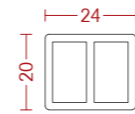

CW Z1061



CW Z0093





Neutra Minimal Sliding

THE FIRST MINIMAL SLIDING IN STEEL

"Harmonizing human action to the order of nature". The lesson of the great modernist architect Richard Neutra is still relevant today, and echoes in today's architecture: a fluid architecture in direct relationship with the landscape. Large glazed openings meet with a new, free design of transparent surfaces and expand in size and value to replace larger and larger portions of the masonry walls.

The large minimal sliding doors, which allow nature to enter the buildings with a single smooth movement, are the result of a revolutionary intuition of another great modernist, Le Corbusier, to whom steel - thanks to its properties of strength and flexibility - allowed a new construction language.

Neutra Minimal Sliding wants to bring back that vision: the same unmistakable style, the same ambition to innovate. Finally back in steel, finally with thermal break. Neutra's steel is the best AISI 316L stainless steel, the so-called 'marine steel' for its exceptional corrosion resistance. A noble metal rich in history that does not follow form and function: it enables them. Restoring to architects and designers the pleasure of truly excelling.

Neutra Minimal Sliding is the first minimal sliding in steel: incredibly reduced visible sections, fully recessed frame, both wall and floor, huge openings with high-performance glazing.

The large glass panes are the result of the latest technological research, which makes it possible to combine huge dimensional ranges and extremely thin profiles (20 mm for the central section between the sliding panels), while maintaining the greatest ease and weightlessness of motion.

Neutra is the latest evolution in minimal sliding, with a visionary design and unprecedented performance.

IL PRIMO SCORREVOLE MINIMALE IN ACCIAIO

"Intonare l'azione dell'uomo all'ordine della natura". La lezione del grande architetto modernista Richard Neutra è ancora attuale, e riecheggia nell'architettura di oggi: un'architettura fluida in diretto rapporto con il paesaggio. Grandi aperture vetrate si incontrano con una nuova, libera progettazione delle superfici trasparenti e si espandono, in grandezza e valore, a sostituire porzioni sempre più ampie di pareti murarie.

I grandi serramenti scorrevoli minimali, che permettono con un unico fluido movimento di far entrare la natura negli edifici, nascono da un'intuizione rivoluzionaria di un altro grande modernista, Le Corbusier, cui l'acciaio - grazie alle sue caratteristiche di robustezza e flessibilità - permise un nuovo linguaggio costruttivo.

Neutra Minimal Sliding vuole riportare indietro quel sogno: lo stesso stile inconfondibile, la stessa ambizione di rivoluzionare. Finalmente di nuovo in acciaio, finalmente a taglio termico. L'acciaio di Neutra è il miglior acciaio inossidabile AISI 316L, il cosiddetto "acciaio marino" per le sue eccezionali caratteristiche di resistenza alla corrosione.

Un metallo nobile e ricco di storia che non segue la forma e la funzione: le abilita. Restituendo ad architetti e progettisti il piacere di distinguersi davvero.

Neutra Minimal Sliding è il primo scorrevole minimale in acciaio: sezioni a vista incredibilmente ridotte, telaio completamente incassato, sia a parete che a pavimento, enormi specchiature con vetri performanti.

Le grandi lastre vetrate sono il risultato dell'ultima ricerca tecnologica, che permette di combinare enormi campi dimensionali ed estrema esilità dei profili (20 mm per il nodo centrale tra le ante scorrevoli), mantenendo massima facilità e leggerezza di scorrimento.

Neutra è l'evoluzione del concetto di minimal sliding, con un design visionario e performance senza precedenti.



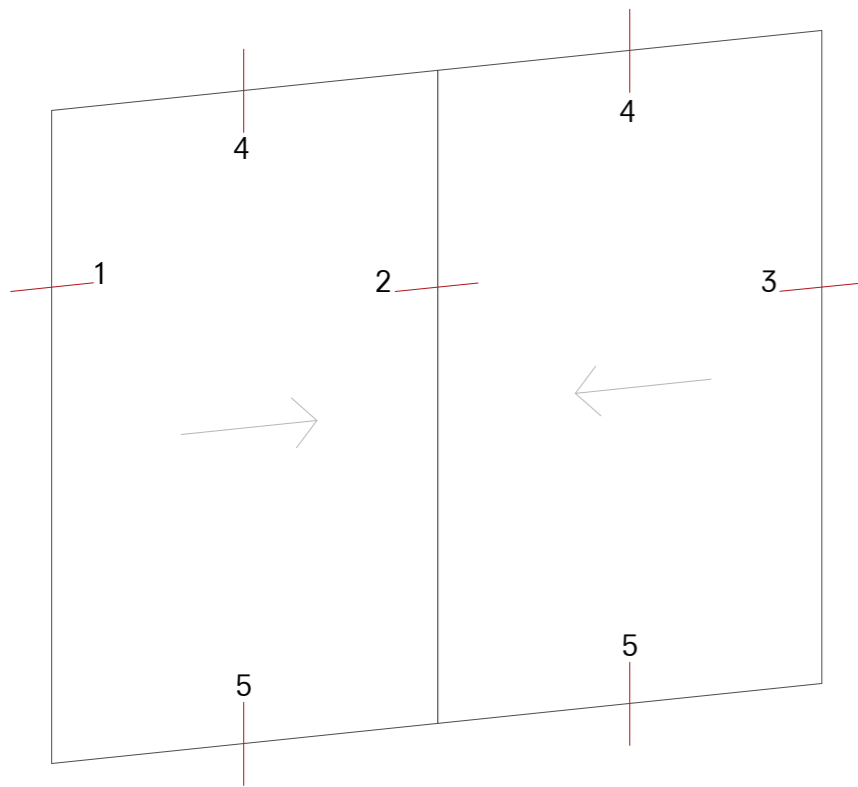

SISTEMI SCORREVOLI | SLIDING SYSTEMS

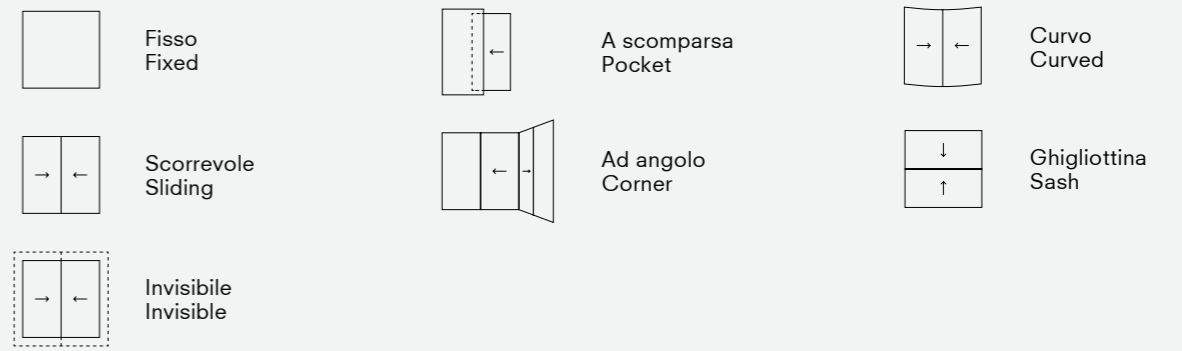

PERFORMANCE

Coefficiente termico Thermal coefficient	up to $U_w = 0,75W/m^2K$	Resistenza al vento Wind resistance	Classe C5
Tenuta all'aria Air tightness	Classe 4	Isolamento acustico Sound insulation	up to 41 db
Tenuta all'acqua Water tightness	Classe E900	Resistenza al fuoco Fire resistance	EI 15

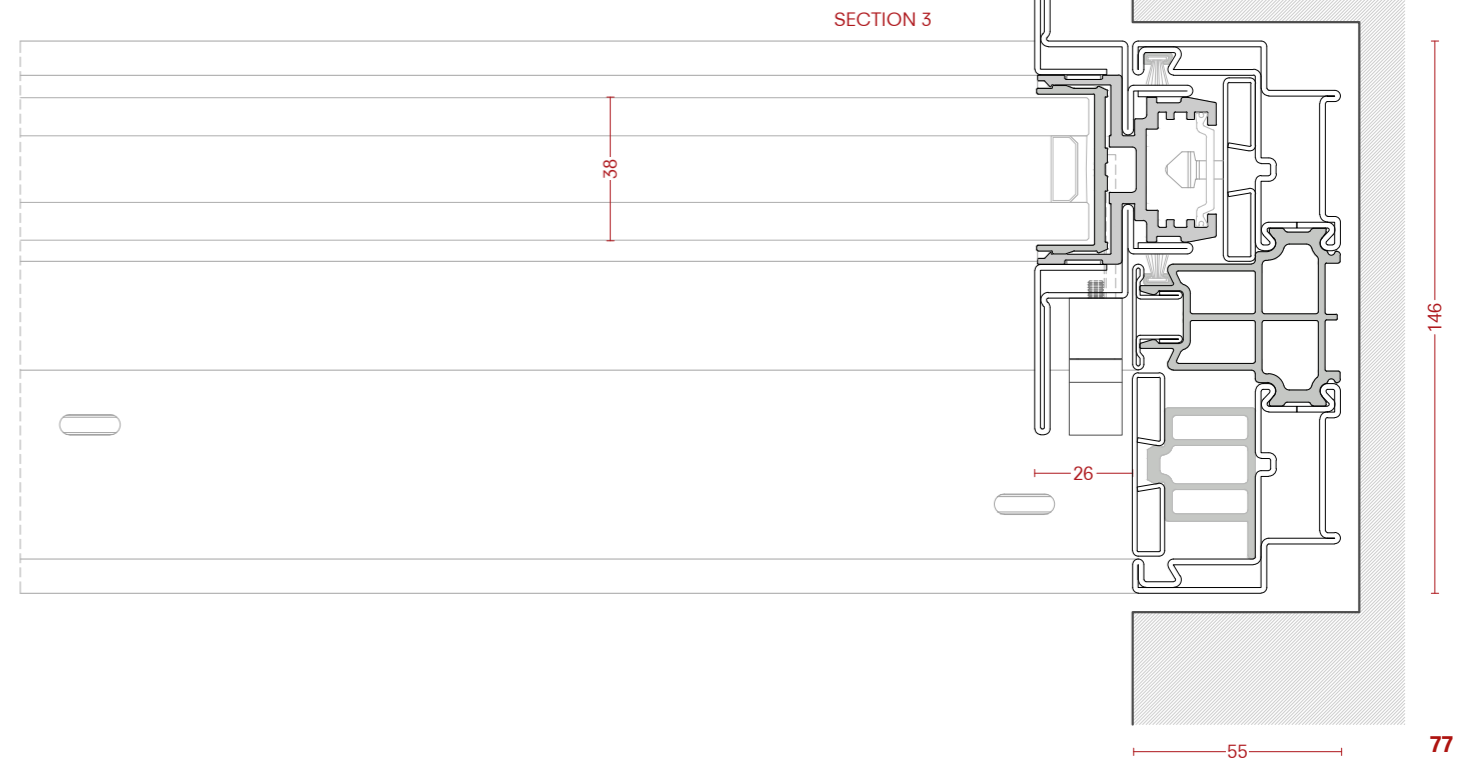
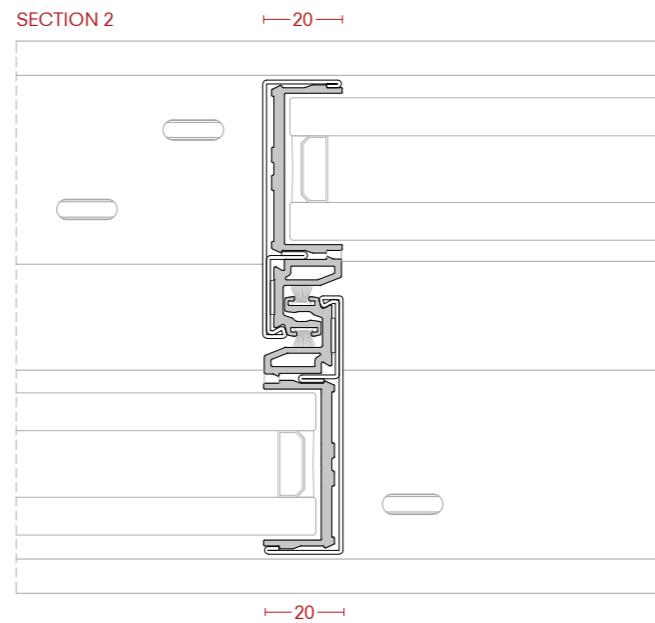
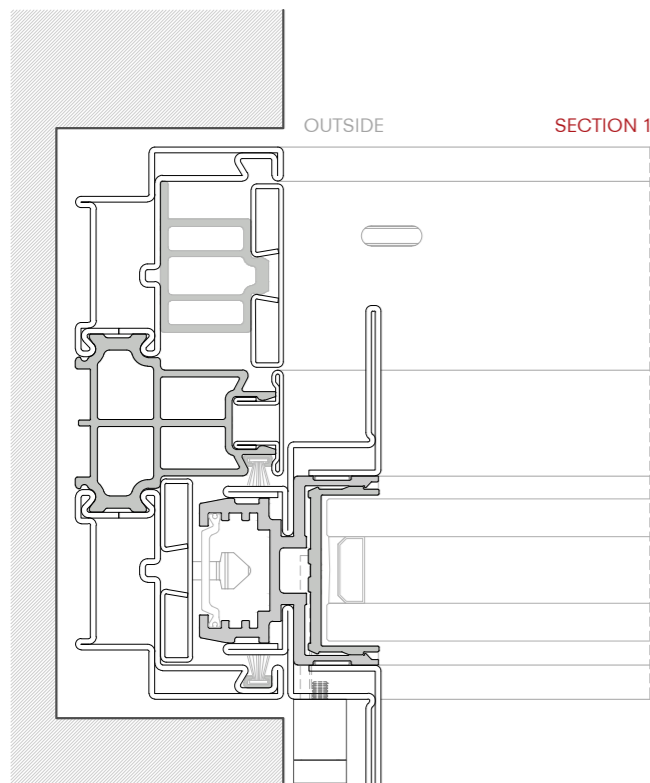

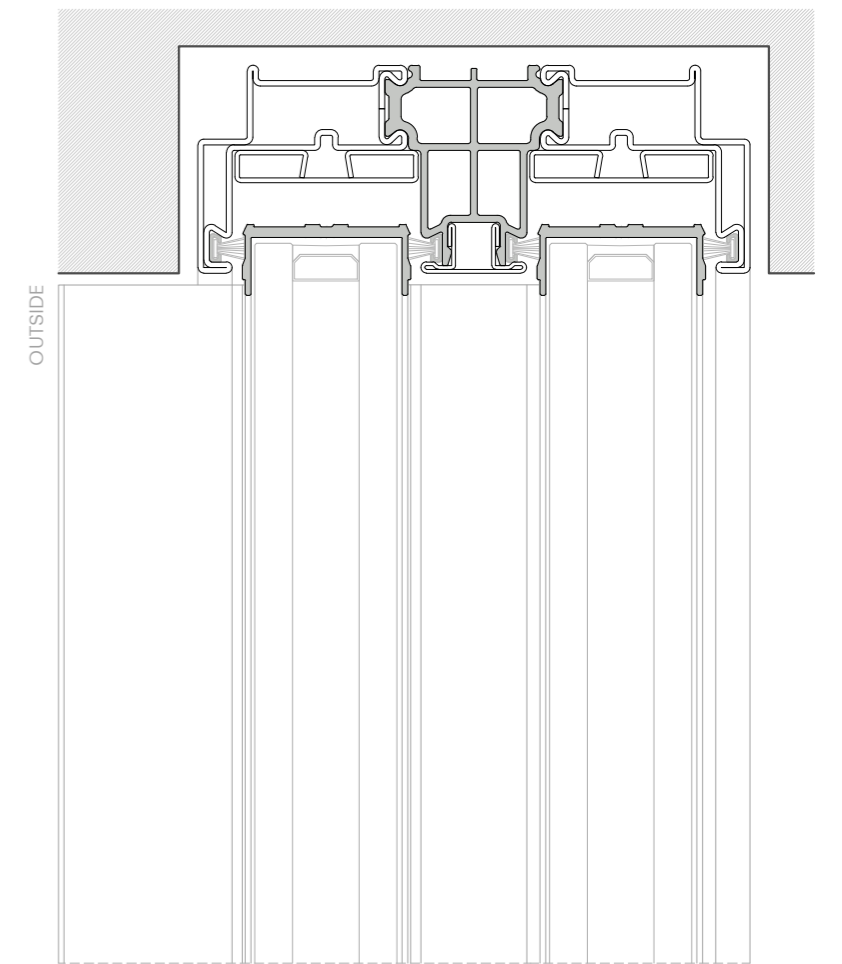

SECTION 4

SECTION 5

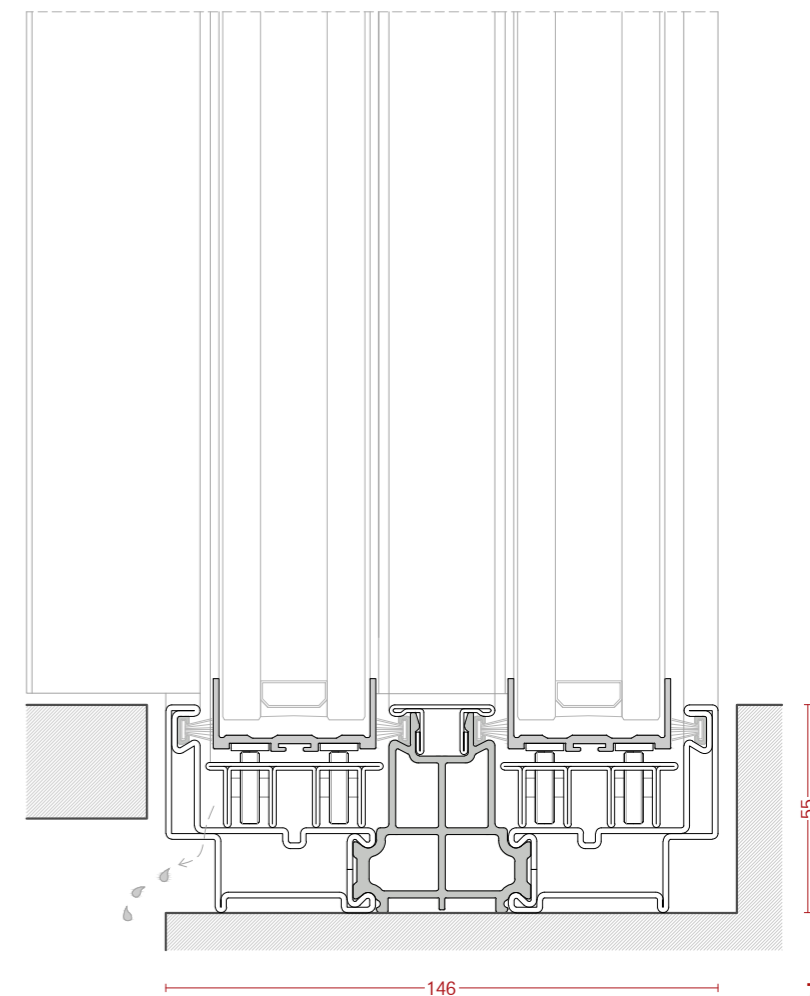



DISCLAIMER

We reserve the right to make technical improvements or modifications of any type even during the validity of this catalogue without prior notice to the customer. Ottostumm SA and Mogs srl take no liability for misprints or mistakes in scale reproductions.

No part of this catalogue may be published, distributed, extracted, reused, or reproduced in any form except under written permission by Ottostumm SA or Mogs srl. Technical drawings are for guidance only and must be studied and verified from a mechanical, functional and static point of view, relieving the companies of every responsibility of any kind. The surface finishes of the items - as represented in this catalogue - are purely indicative.

For all the rest, please refer to the sales conditions of the company that issued the order confirmation.

AVVERTENZE

Ci riserviamo la facoltà di apportare miglioramenti tecnici o modifiche di qualsiasi tipo anche nel corso di validità del presente catalogo senza alcun preavviso. Nessuna responsabilità è imputabile a Ottostumm SA o a Mogs srl per errori tipografici o nelle riproduzioni in scala. È vietata la riproduzione anche parziale, la pubblicazione, la distribuzione, il riutilizzo con qualsiasi mezzo effettuato o l'estrazione in copia del presente catalogo se non con preventiva autorizzazione scritta da parte di Ottostumm SA o Mogs srl.

I disegni tecnici sono puramente indicativi, ogni applicazione deve essere studiata e verificata da un punto di vista meccanico, funzionale e statico, sollevando Ottostumm SA e Mogs srl da ogni responsabilità di qualsiasi tipo. Le finiture degli articoli – così come rappresentate in questo catalogo – sono puramente indicative. Per tutto il resto, si prega di fare riferimento alle condizioni di vendita della società che ha emesso la conferma d'ordine.

Printed: October 2023

OTTOSTUMM | **mogs**

OTTOSTUMM SA

Via Baragge, 2 - 6855 Stabio - Switzerland

Mogs srl unipersonale

Viale Trento e Trieste, 12 - 31100 Treviso - Italia

ottostumm-mogs.com